

## Important Before You Start: THIS IS A “QUICK SET-UP” GUIDE ONLY

Please refer to the **Operation / Service Technical Manual** for full set-up and usage instructions. Failure to carefully read and follow all instructions and safety information may result in decreased product performance or injury.

**NOTE:** Controller User Interface may vary from instructions.

### Controller Pre-Assembly

1. Remove components from their individual packaging containers.
2. Place controller on a flat, stable surface, away from any edges to prevent fall damage.
3. Insert latching power cord as shown.
4. Confirm proper insertion with a slight pull.
5. If applicable, assemble controller mounting accessories per the separately supplied user instructions. **(RECOMMENDED)**

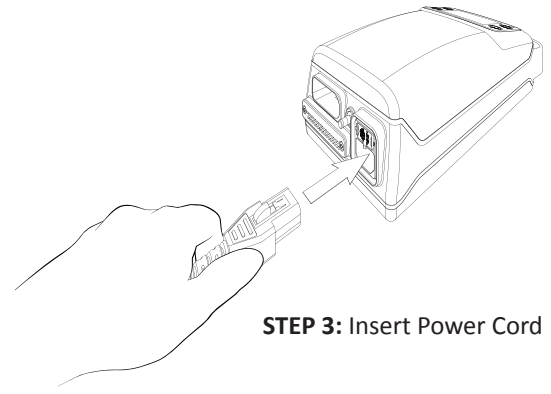

**STEP 3:** Insert Power Cord

### System Installation - Controller

6. Place controller in a safe, stable location near a wall power outlet and at an appropriate distance from the patient care area.
7. Route the power cord such that it does NOT present a trip hazard.
8. Plug the power cord into the AC wall receptacle or other power source with appropriate currents and protective earth ground.

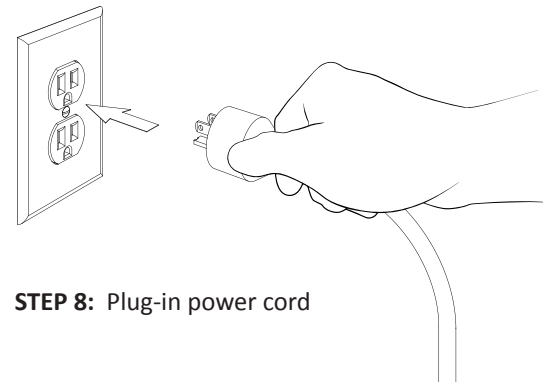

**STEP 8:** Plug-in power cord

### System Installation - Surfaces

9. Place Surface onto flat mattress with “THIS SIDE UP” facing up (gray side down) and secure optional corner straps when applicable. (Surface should lay flat when properly installed.) Hose exit orientation is optional depending on the desired set-up.
10. Place facility supplied linen and incontinence pad(s) over the top of the surface and tuck edges underneath the mattress. Avoid wrinkles whenever possible to optimize performance and patient comfort.

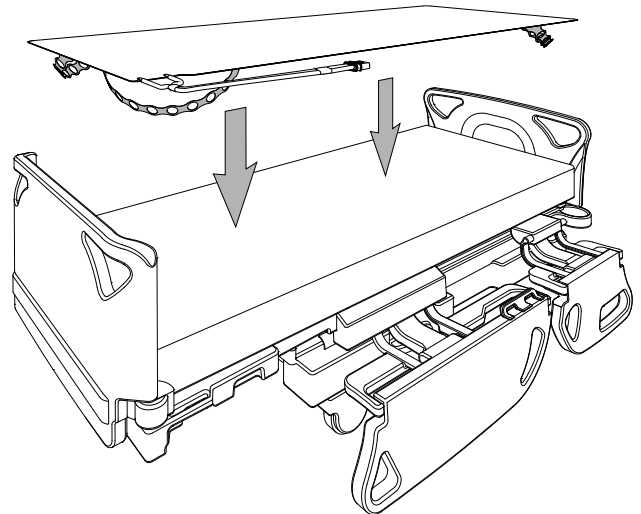

**STEP 9:** Place surface onto flat Mattress



### WARNINGS / CAUTIONS:

- Surfaces are intended to be used ABOVE an underlying bed mattress with good pressure redistribution properties over the full patient contact area.
- Always place the surface ABOVE the mattress and cover it with a bed linen. (Surfaces are NOT intended to be used in direct contact with the patient’s skin.)
- It is the responsibility of the user to secure and protect against patient movement and/or falls.
- It is the responsibility of the user to properly clean and disinfect the System prior to patient use. (Visit [agilithhealth.com/clinical-support/patient-care-plus-resources](http://agilithhealth.com/clinical-support/patient-care-plus-resources) for a list of approved & unapproved cleaners.)

**Corporate Headquarters:**

Agiliti Health, Inc, 11095 Viking Drive, Suite 300, Eden Prairie, MN 55344 Tel: +1(800)847-7368

**Manufacturer:**

Raye’s, Inc, d/b/a Sizewise Manufacturing, 252 Mariah Circle, Corona, CA 92879 Tel: +1(888)208-4599

**Sales:**

[agilithhealth.com/contact](http://agilithhealth.com/contact)

**Technical and Warranty Support:**

[agilithhealth.com/contact](http://agilithhealth.com/contact) Tel: +1(888)559-3641

**Website:**

[agilithhealth.com/product/patient-care-plus](http://agilithhealth.com/product/patient-care-plus)

DOC# R02-0006-00014-LA



## Quick Set-Up Guide - Continued

### System Installation - Surface Connections

11. Insert Surface connector as shown.
12. Listen for an insertion "CLICK" to confirm proper connection.

**NOTE:** Session will start automatically if powered "ON".

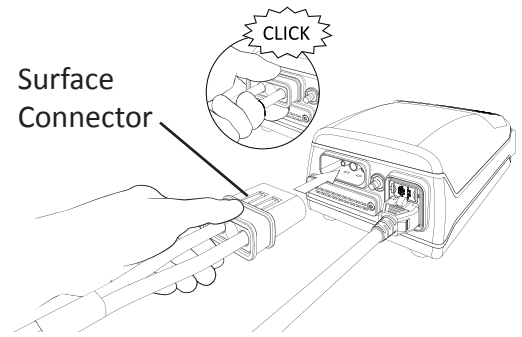

STEPS 11 & 12: Connector Insertion

### Controller Operation: "ON", "OFF" and "PAUSE" Mode

13. **POWER "ON":** Touch and hold the "POWER" key until the "START-UP" screen appears. Session will automatically begin if a Surface is connected.

14. **POWER "OFF":** Touch and hold the "POWER" key until the "OPTIONS" Menu appears. Select "SHUTDOWN" by touching "POWER" key for 2 seconds.

15. **"PAUSE" MODE:** Touch and hold the "POWER" key until the "OPTIONS" screen appears, then select "PAUSE" to temporarily stop the session. (Default is 30 minutes.) Select "RESUME" at anytime to immediately resume the session.

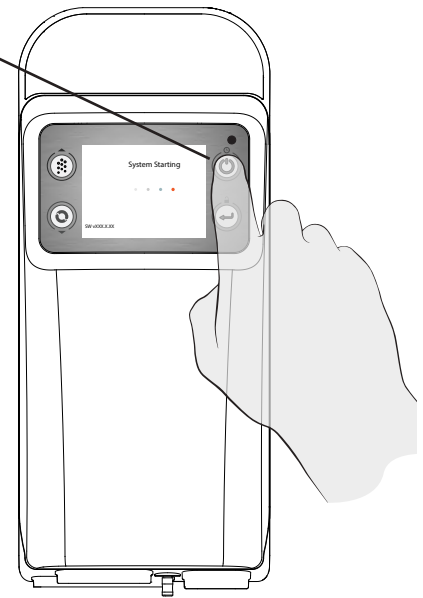
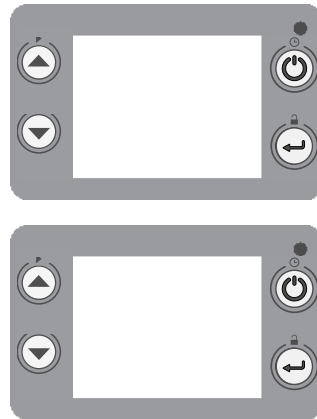

STEP 13: Power controller "ON"

16. **"KEY LOCK" MODE "ON" / "OFF":** Touch and hold the "SELECT" key for 4 seconds to "LOCK" display. (Yellow lock symbol will appear.) Touch and hold the "SELECT" key for another 4 seconds to "UNLOCK" the display. (Yellow lock symbol will disappear.)

### Getting familiar with the Controller User Interface:

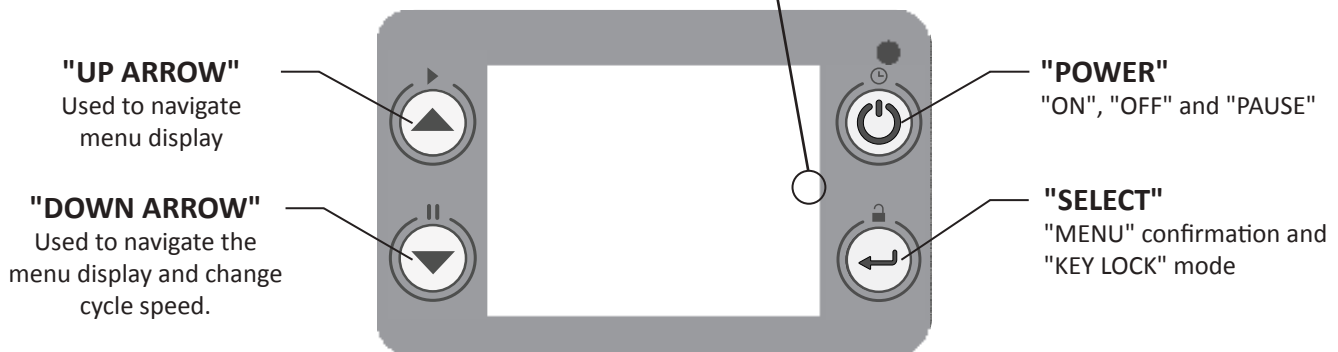

**NOTE:** To change cycle speed on Patient Care™ models, press the "MICROPRESSURE" key



### ⚠️ WARNINGS / CAUTIONS:

- The session is NOT provided unless the Controller is powered "ON" and the Surface is actively cycling.

**Corporate Headquarters:** Agiliti Health, Inc, 11095 Viking Drive, Suite 300, Eden Prairie, MN 55344 Tel: +1(800)847-7368  
**Manufacturer:** Raye's, Inc, d/b/a Sizewise Manufacturing, 252 Mariah Circle, Corona, CA 92879 Tel: +1(888)208-4599  
**Sales:** agilitihealth.com/contact  
**Technical and Warranty Support:** agilitihealth.com/contact Tel: +1(888)559-3641  
**Website:** agilitihealth.com/product/patient-care-plus  
 DOC# R02-0006-00014-LA

