

**Detachable  
Quick Reference Guide**  
*see back of manual*



**Arise™ 1000EX**  
Low Air Loss Therapy  
Mattress (LAL)

**Model 2236**

# stryker®

## Operations/Maintenance Manual



For Parts or Technical Assistance:  
USA: 1-800-327-0770 (option 2)





# Table of Contents

---

Symbols and Definitions . . . . .	4
Warning / Caution / Note Definition. . . . .	4
Introduction . . . . .	5
Intended Use . . . . .	5
Product Description . . . . .	5
Specifications . . . . .	6
Environmental Conditions . . . . .	6
Therapy Mattress System Illustration . . . . .	7
Therapy Control Unit Illustration . . . . .	7
Product Features . . . . .	8
Indications for Use . . . . .	9
Therapy Pads . . . . .	9
Key Areas in the Treatment of Compromised Skin . . . . .	10
Summary of Safety Precautions . . . . .	11
Bed System Entrapment Information. . . . .	12
Grounding Instructions . . . . .	12
Setup Procedures. . . . .	13
Operation Guide . . . . .	15
Patient Comfort Controls and Monitoring . . . . .	15
CPR . . . . .	16
Transport. . . . .	16
Power Failure . . . . .	16
CairRails . . . . .	16
Nursing Procedures . . . . .	17
Recommended Linen . . . . .	17
Changing the Therapy Pad. . . . .	17
Patient Positioning and Comfort . . . . .	17
Incontinence . . . . .	17
Safety Information . . . . .	17
Cleaning, Storage and Care . . . . .	18
Control Unit . . . . .	18
General Cleaning. . . . .	18
Disinfecting . . . . .	18
Therapy Pad . . . . .	19
Steam Cleaning . . . . .	19
Filter Cleaning . . . . .	19
Storage . . . . .	19
Preventative Maintenance . . . . .	20
Maintenance Checklist. . . . .	20
Troubleshooting . . . . .	21
Quick Reference Replacement Parts List . . . . .	22
Warranty . . . . .	28
Arise™ 1000EX, Low Air Loss Therapy Mattress Quick Reference Guide . . . . .	29

# Symbols and Definitions

---

	Warning / Caution - Consult accompanying documentation
	Maximum Safe Working Load
	Medical Equipment Classified by Underwriters Laboratories Inc. with respect to Electric Shock, Fire, Mechanical and Other Specified Hazards Only in Accordance with UL 60601-1, First Edition (2003) and CAN/CSA C22.2 No. 601.1-M90 with updates 1 and 2.

## WARNING / CAUTION / NOTE DEFINITION

The words WARNING, CAUTION, and NOTE carry special meanings and should be carefully reviewed.

---

### **WARNING**

Alerts the reader about a situation, which if not avoided, could result in death or serious injury. It may also describe potential serious adverse reactions and safety hazards.

---

### **CAUTION**

Alerts the reader of a potentially hazardous situation, which if not avoided, may result in minor or moderate injury to the user or patient or damage to the equipment or other property. This includes special care necessary for the safe and effective use of the device and the care necessary to avoid damage to a device that may occur as a result of use or misuse.

### **Note**

This provides special information to make maintenance easier or important instructions clearer.

# Introduction

---

## INTENDED USE

This manual is designed to assist you with the safe operation and maintenance of the Arise® 1000EX, Low Air Loss (LAL) mattress system. Carefully read this manual thoroughly before using the equipment or beginning maintenance on it. To ensure safe operation of this equipment, it is recommended that methods and procedures be established for educating and training staff on the safe operation of this Arise® mattress system.

This high quality medical product, when properly installed and cared for will provide many years of trouble free service, and outstanding clinical performance.

## PRODUCT DESCRIPTION

The Arise® is a unique therapy system that provides pressure relief by combining low air loss with pulsation. Low air loss therapy has been demonstrated to reduce the risk of pressure ulcers as well as being a valuable aid in the treatment of pressure ulcers. The Arise® is available as a mattress replacement system and as a mattress overlay.

The Arise® mattress system is suitable for both the treatment of existing pressure ulcers stage I through stage IV as well as those who have been assessed at risk from the complications of immobility. The Arise® is quiet, comfortable and simple enough for single caregiver installation, featuring rapid inflation in just three to five minutes. The user-friendly controls allow for easy adjustment of patient comfort. The Arise® offers special features to increase peace of mind such as a power interruption alarm and a patient position sensor which optimizes support for seated patients (Fowler Boost).





Additionally, low friction and shear materials, together with average interface pressures below capillary closure levels (32mm of Mercury), means that the Arise® meets the comfort and clinical requirements.

# Introduction

## SPECIFICATIONS

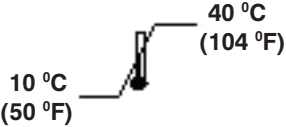
<b>Model</b>	<b>Arise 1000EX</b>	2236-000-001	Mattress
<b>Dimensions (Mattress)</b>	Width	36", 42", 48"	91 cm, 107cm, 122 cm
	Length	80", 88"	203 cm, 224 cm
	Thickness	8.5"	22 cm
<b>Dimensions (Control Unit)</b>	Width	13.5"	34 cm
	Height	11"	28 cm
	Depth	7.5"	19 cm
<b>Weight</b>	Mattress	24.5 lbs	10 kg
	Control Unit	10 lbs	4.5 kg
<b>Safe Working Load (Max Patient Weight)</b>		1000 lbs	454 kg
<b>Electrical Specifications</b>	USA	120VAC, 60Hz, 4A, less than 1A running	
<b>Classification</b>		UL Classified Medical Equipment, UL 60601-1, Can/CSA C22.2 No. 601.1 <b>Note:</b> UL Classification refers to the power unit only, not the complete mattress replacement system.	

## ENVIRONMENTAL CONDITIONS

Environmental Conditions	Operation	Storage and Transportation
Ambient Temperature		
Relative Humidity (Non-Condensing)		

**Stryker reserves the right to change specifications without notice.**

Specifications listed are approximate and may vary slightly from unit to unit or by power supply fluctuations.

# Introduction

---

## THERAPY MATTRESS SYSTEM ILLUSTRATION



## THERAPY CONTROL UNIT ILLUSTRATION



# Introduction

---

## PRODUCT FEATURES

The Arise® is comprised of two components:

1. Therapy Control Unit
2. Therapy mattress System

### Therapy Control Unit Features

- True low air loss with up to 100 liters of airflow per minute.
- Three modes of operation – Autofirm, Therapy and Pulsate.
- Pulsating feature that oscillates the air throughout the mattress every 30 seconds.
- Autofirm mode provides maximum air inflation designed to assist both patients and caregivers during patient transfer and treatment.
- Patient position sensor optimizes support for seated occupants (Fowler Boost).
- Compact lightweight control unit is quiet, robust and powerful, with a reusable air filter and integrated carrying handle for portability.
- Crisp, easy to read graphics for intuitive set up and therapy control.
- Automatic panel lock out to avoid unwanted or accidental adjustments.
- Eight therapeutic comfort control settings to maximize patient compliance and promote healing.
- Closed loop pressure sensor control system eliminates concerns of changes in mattress interface pressure due to ambient temperature and pressure changes.
- Integrated swing out hanging brackets for fixing to most bed frames.
- Quick disconnect hose feature allows for rapid attach and CPR deflate at the control unit.
- Audible and visual alarms for power interruptions.

### Therapy Mattress System

- Caregiver operated mattress control panel to adjust the following mattress features:
  - Independent inflation and deflation control of the 6" wide side bolsters (left and right) when used in combination with the Bari10A bed (36, 42 or 48 inches wide) allows for close-in nursing procedures that may otherwise be a strain on the care giver and transportation through narrow doorways.
  - Inflation and deflation of the CairRails
  - Inflation and deflation of the length extension cells which in combination with the Bari10A bed allow the bed and mattress to extend from 80 to 88 inches in length.
- Sixteen (Eight paired) individual therapy cells help to evenly distribute the patient's weight and maximize pressure relief. Modular cell design mattress for ease of cleaning, re-assembly and cost effective service.
- Lower three-inch foam support cell provides additional therapeutic support and remains supportive in the event of a power failure or for patient transport.
- Five-inch deep therapy cells are constructed of highly durable, polyurethane coated nylon to provide adequate support and prevent bottoming out for most patients within the weight limit.
- Maximum weight capacity: 1000 lbs.\*



# Introduction

---

## INDICATIONS FOR USE

**Note:** The selection of a pressure-relieving surface needs to be based on each individual patient's clinical condition, diagnosis and/or co-morbidities. The choice and use of a support surface is one factor in a holistic program of wound care and treatment.

### Pressure Relief

• Pressure Relief	• Rehabilitation	• Dermatology
• Neurology	• Burns	• Amputations

### Pain Management

• AIDS	• Arthritis	• Oncology
--------	-------------	------------

The Arise® provides uniform distribution of weight over a wide surface area, which relieves pressure against bony prominences and provides a soft, gentle therapy surface to lie on. For patients experiencing severe pain and discomfort due to pressure and/or positioning limitations, consider the Arise as an adjunct to pain management interventions.

**Note:** Pressure relief and pain management are conditions and diagnoses for which the Arise® may be indicated. Occasionally, there are orthopedic and neurological patients that require body positioning to be maintained in specific alignment. The Arise® has safety features to prevent deflation of the therapy cells and to keep patients from bottoming out at all times. The use of the Arise® for these patients should be considered on an individual basis and discussed with the attending physician.

## THERAPY PADS

Many healthcare facilities are facing the challenge of infection control. This products quilted therapy pads are treated with an antimicrobial to protect the therapy pad from the growth of mold, mildew and bacteria.

### Key features and benefits:

- Treated with a highly effective bacteriostat agent to inhibit the growth of bacterial and fungus
- Constructed from a very smooth nylon fabric with low friction and low shear properties to protect the patient's skin from damaging friction/shearing forces.
- Breathable, moisture vapor permeable fabric allows air to circulate beneath the pad and wicks away excess moisture. This keeps your patient dry and helps to prevent skin maceration.
- Two-way stretch therapy pad is designed for optimal comfort, moisture vapor transfer, stain resistance and ease of laundering.

# Introduction

---

## KEY AREAS IN THE TREATMENT OF COMPROMISED SKIN

### **Pressure Relief**

The Arise® is divided into three distinct anatomical zones: head, seat, and foot. Each zone is adjusted to ensure optimal pressure relief and provide a comfortable sleeping surface.

Maximum pressure relief is achieved through delivering a specific amount of air to each therapy cell and allowing controlled amounts of air to escape, thus equalizing the pressure between the patient and the therapy cells. This distributes the patient's weight evenly over a wide surface area resulting in average pressure readings below capillary closure levels.

### **Moisture Control**

Patients are at risk for skin maceration if excess moisture is permitted to accumulate beneath the patient. This may be due to perspiration, incontinence or wound drainage.

On the Arise®, moisture is controlled via the specially treated breathable, fluid-proof, urethane coated nylon therapy pad. The moisture vapor permeable fabric of the therapy pad allows a sufficient amount of air to circulate beneath the pad and wicks away excess moisture.

### **Shear and Friction Reduction**

Shearing occurs when the skin is stationary in relation to the support surface, while the underlying tissues and vessels are stretched and damaged. When a patient's skin rubs against another surface, the result is friction. The top surface of the Arise® therapy pad is constructed from a very smooth nylon fabric with low friction and shear properties to protect the patient's skin from these damaging forces.

# Summary of Safety Precautions

---

**Important Notice:** The equipment has to be installed and operated in the manner for which it was intended. Facility staff/user is responsible for reading and understanding the product user manual prior to performing any operations or maintenance on this product.

---

## WARNING

---

- The safe use of the equipment is maximized when used in conjunction with bed rails; there may be an increased risk of falls when such bed rails are not present. Serious injury or death can result from the use (potential entrapment) or non-use (potential patient falls) of side rails or other restraints. Local policies regarding the use of side rails should be taken into account. Whether and how to use side rails is a decision that should be based on each patient's individual needs and should be made by the physician, caregivers and responsible parties.
- When using the Arise® mattress system, always ensure that the patient is positioned properly within the confines of the bed. Do not let any extremities protrude over the side or between the bed rails when the mattress is being used.
- Do not use in the presence of flammable anesthetics. Do not use in the presence of smoking materials or open flame. Air flowing through the air mattress will support combustion.
- To reduce the risk of shock, adhere to the following instructions. Failure to do so could result in personal injury or equipment damage.
  - Immediately after using the Arise®, unplug it from its power source.
  - Do not place or store the product where it can fall or be pulled into a tub or sink.
  - Do not place or drop the product into water or other liquid.
  - Do not remove the back of the control unit.
- To reduce the risk of burns, shock, fire, or personal injury, adhere to the following instructions. Failure to do so could result in personal injury or equipment damage.
  - Use this product only for its intended purpose as described in this manual. Only use attachments and/or accessories that are recommended by the manufacturer.
  - If this product has a damaged power cord or plug, is not working properly, has been dropped or damaged, or has been dropped into water, do not operate it. For examination and repair, return the product to the manufacturer.
  - Keep the control unit and power cord away from heated surfaces, e.g. space heaters.
  - Never block the air openings of the product. Do not place the control unit on a surface, such as a bed or couch, where the air opening and/or filter compartment, located on the back of the control unit, may be blocked. Keep the air openings free of lint and hair.
  - Never drop or insert any object into any opening or hose.
  - Do not spill food or liquids onto the control unit. If a spillage does occur, turn off the unit, disconnect it from its power supply and allow at least 24 hours for drying.
  - Do not use the product outdoors, or where aerosol-spray products are used.
  - Plug this product only into a properly grounded outlet. Refer to Grounding Instructions on [page 12](#).
  - Be sure nothing is placed on the power cord and ensure it is not located where it can be stepped on or tripped over.
  - Do not attempt to service the control unit. Please call Stryker at 1-800-327-0770 for any service requests.
  - The therapy pad (top cover) of this product is not air permeable and may present a suffocation risk. It is the responsibility of the caregiver to ensure that the patient can use this product safely.
- The risk of entrapment can develop when equipment is placed on bed frames that leave gaps of even a few inches between the mattress and the headboard, footboard, and bed or side rails. The equipment is NOT to be used when such gaps are present.

## CAUTION

---

- CairRails (side air bolsters), when inflated, offer additional support and provide a gentle reminder to the patient that they are nearing the side edge of the mattress.

---

[Return To Table of Contents](#)

# Summary of Safety Precautions

---

## BED SYSTEM ENTRAPMENT INFORMATION

Although common in the practice of long-term care, bedside rails, in recent years, have also been a subject of regulatory review and evolution in design and use.

That focus includes not only the challenge of achieving an appropriate balance between resident security and unnecessary restraint, but also the additional safety issue of entrapment.

The U.S. Food and Drug Administration (FDA), has addressed the potential danger of entrapment with new safety guidelines for medical beds. These guidelines recommend dimensional limits for critical gaps and spaces between bed system components.

Entrapment zones involve the relationship of bed components often directly assembled by the healthcare facility rather than the manufacturer. Therefore, compliance is the responsibility of the facility.

## GROUNDING INSTRUCTIONS

---

### WARNING

Use a properly grounded, three-prong, 120V AC outlet for this product. Failure to use a grounded outlet could result in personal injury or damage to equipment or house wiring, including risk of fire. A qualified electrician should be contacted to correct the wiring and ensure a properly grounded outlet.

#### Note

- Before installing this product, have the electrical system checked to make sure the electrical circuits and the electrical service are properly grounded.
- Having a three-prong outlet does not necessarily mean it is grounded. Sometimes two-prong outlets are replaced with a three-prong type even though there is no ground wire.
- There is always a chance of a loose connection or poor installation of a ground wire that causes the loss of proper ground at the outlet. Inadequate grounding at electrical outlets can occur even if there is a ground wire. Wires can become loose over time at the connection to the outlet.

### CAUTION

A qualified electrician is required for the installation of new wires on a circuit.

## How to Determine if Your Outlet has the Proper Grounding

Most hardware stores sell circuit testers (see Figure 2) that can be used to test an outlet for proper grounding. The tester plugs into an outlet and by observing the indicator lights you can determine if the outlet is properly grounded. For a higher level of assurance, an electrician should be requested to thoroughly test the electrical system with more reliable equipment.

If repair or replacement of the cord or plug is necessary, please contact Stryker at 1-800-327-0770.



Figure 2

# Setup Procedures

## WARNING

Ensure you have read and understand all Safety Precautions listed on [page 11 - 12](#) prior to performing the setup procedures below.

1. Remove the existing mattress from the bed.
2. Place the Arise® 1000EX mattress with the hose connection at the foot end of the bed and the therapy cells facing up. Secure the eight (8) straps on the mattress securely to the loops provided on the Bari10A bed frame.  
**Note:** These straps should not be over tightened as they may interfere with the Bari10A bed deck elements during width reduction.
3. If the therapy pad is not already on the mattress, attach it via the longitudinal zippers to the mattress.  
**Note:** This will require threading the hose set through the control window opening on the therapy cover located on the mattress side at the patients left foot. Also attach the snaps around the control panel opening from the therapy cover to the mattress control panel in four (4) places so that the control panel is not obscured (see Figure 3).
4. Hang the control unit on the foot of the bed facing away from the bed. Attach the hose connector marked CPR to the underside of the control unit (see Figure 4a). **Note:** To disconnect see Figure 4b.



Figure 3



Figure 4a - connect hose

[Insert hose into air blower. Ensure tabs snap securely in place.]

Figure 4b - disconnect hose

[Squeeze tabs on the sides and pull down.]

5. Plug the Fowler boost sensor into the side of the control unit.
6. Plug in the control unit and the yellow *Standby* light will illuminate. Press the **Power** key. The control unit will start and the green light will illuminate.
7. Allow three to five minutes for full inflation. Place the patient on the mattress. Mattress can be inflated with patient on it, but will take longer, depending on patient weight/size.  
**Note:** Keep the control unit on while the patient is on the mattress.

[Return To Table of Contents](#)

# Setup Procedures

- Position the patient's head in the position in which the patient will be for the largest portion of the day. If the patient is lying flat, please use two (2) fingers for the hand check. If the patient will be sitting up for the majority of the day, please use one (1) finger.
- Perform a hand check by placing fingers locally under the patient's buttocks between two cushions above the foam base. The patient should not bottom out. If they do, increase the therapy control by one comfort level, until they no longer are in contact with the 3" foam base. If the patient continues to touch the foam base or is uncomfortable at higher comfort settings, the mattress will still provide therapy relief and wicking away of accumulated moisture via the low air loss feature.
- The CairRails air bolsters can be inflated or deflated as required. Locate the control knob (see Figure 3) on the lower right of the control panel on the mattress. Next, inflate/deflate the CairRails by moving the control knob to the up (inflate) or down (deflate) position.

- If the patient needs the extended width functionality of the bed (36", 42" or 48") then complete the following procedure.

**Note:** this can be accomplished with the patient on the bed:

- Adjust the Bari10A bed frame with the knee section in the flat position.
- Widen the bed frame (see bed manual)
- Un-strap the mattress side straps from the Bari10A bed frame.
- Un-snap the pocket that contains the extension side cells so they are free to inflate.
- Attach the extended width mattress side straps to the extended bed deck (Note: do not over tighten).
- Inflate the extension side cells by turning the lower left knob on the mattress control panel up. After 2-5 minutes the cells will inflate. Leave the knob in this position to maintain inflation.

- If the patient needs the extended length functionality of the bed (80" - 88" then complete the following procedure.

**Note:** this can be accomplished with the patient on the bed:

- Adjust the Bari10A bed frame with the knee section in the flat position.
- Extend the bed frame (see bed manual)
- Un-strap the mattress foot straps from the Bari10A bed frame.
- Un-snap the pocket that contains the extension foot cells so they are free to inflate.
- Attach the extended length mattress foot straps to the extended bed deck (**Note:** Do not over tighten).
- Inflate the extension foot cells by turning the lower left knob on the mattress control panel (see Figure 5) up. After 2-5 minutes the cells will inflate. Leave the knob in this position to maintain inflation.

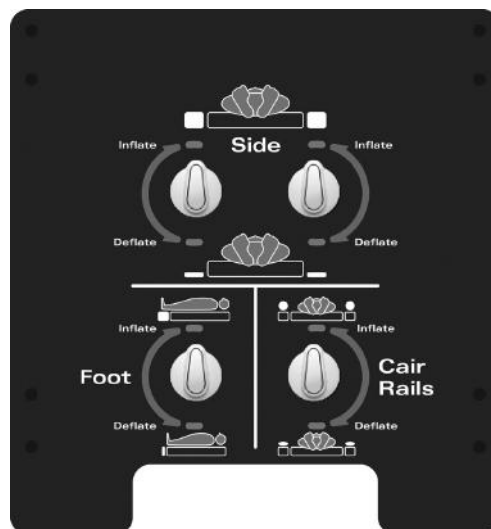

Figure 5

# Operation Guide

## CAUTION

The patient's head should be positioned in the center of the top section of the mattress. When using the mattress system always ensure that the patient is positioned properly within the confines of the bed. Do not let any extremities protrude over the side or between the bed rails when the mattress is being used.

## PATIENT COMFORT CONTROLS AND MONITORING

(Refer to Figure 6)

### Power Switch

The power switch is used to turn the power on and off.

### Standby Light

The *Standby* indicator will illuminate when the unit is plugged into a power outlet. Press the **Power** button to turn the unit on and inflate the mattress. Therapy is the default mode at startup. When the *Standby* light is on, it may also indicate that there has been a power interruption and the therapy control unit is ready to be turned back on. Press the **Power** button and reset the preferred mode of therapy and comfort level.

### Modes

The Arise® has two low air loss therapy modes, Therapy and Pulsate and an Autofirm mode

1. **Therapy:** The unit starts in the Therapy mode, which is the standard low air loss therapy.
2. **Pulsate:** Pulsate will slightly decrease the pressure in all cushions every 30 seconds then return to the programmed comfort adjust level.
3. **Autofirm:** Autofirm mode provides maximum air inflation designed to assist both patients and caregivers during patient transfer and treatment. The unit will automatically return to the mode it was in prior to Autofirm (either therapy or pulsate) in approximately 12 minutes.

### Comfort Adjust

The Comfort Adjust function is located on the right side of the control panel. The Arise can be customized to meet individual patient needs within a therapeutic window. Use the up and down keys to simultaneously increase or decrease pressure in all three zones (head, seat and foot). This function will not work in Autofirm mode.

### Lockout

This feature is to prevent any unauthorized changes to the patient settings. To unlock and make adjustments to the settings press both **Up** and **Down** comfort arrows at the same time to disengage the Lockout function. The Lockout function will return in approximately five minutes.

**Note:** The unit is designed to lock out all the adjustment controls after the patient has been positioned correctly. In approximately five minutes after the last button push, the power on light begins to flash indicating Lockout is enabled.

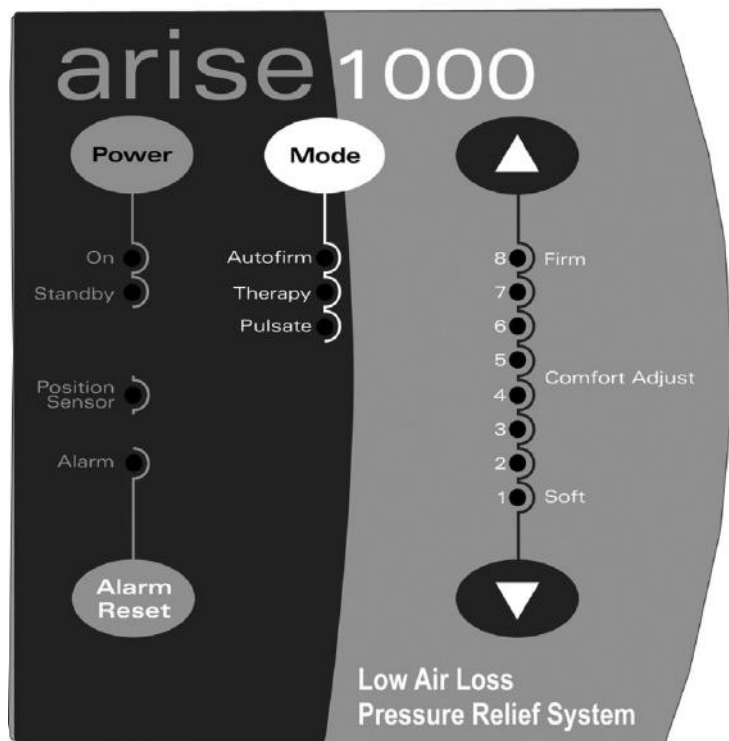

Figure 6



# Operation Guide

---

## CPR

The hose connection at the control unit is marked CPR. Disconnect the hose from the control unit. CPR connection style may vary by model. To re-inflate the air cells, reattach the hose to the control unit.

## TRANSPORT

To transport the patient in bed, turn the control unit off. Unplug the power cord from the outlet. Do not disconnect the hose connection at the control unit. The lower support cell will prevent the patient from bottoming out for up to 12 hours. Some models incorporate a foam safety cell.

For the Arise® 1000EX mattress, the control unit can be disconnected from the mattress as the 3" foam base will continue to support the patient. If the Bari10A bed frame is to be reduced in width for transport it may be necessary to deflate the CairRails. This can be done at the mattress control panel (Figure 5 on [page 14](#)) by turning the lower right control knob down.

## POWER FAILURE

After a power failure the unit will start up in *Standby* mode. Reset the preferred mode and comfort level as described on [page 15](#). In the event of a power failure, the lower support cells will hold air for up to 12 hours. Some models incorporate a foam safety cell. In case of an extended power failure, transfer the patient to a hospital mattress or other surface.

## CAIRRAILS

Integrated CairRails risk management air bolsters offer a bilateral side bolster solution designed to address healthcare's growing concerns of liability in relation to patient falls and entrapment. CairRails are being recognized by some of the nations leading healthcare systems for improving their patient safety and risk management programs.

CairRails are recommended for patients requiring additional support during patient care and transfer. CairRails can help reduce costs while ensuring optimal clinical outcomes and increasing patient safety.

**Note:** When inflating CairRails, it is recommended that the control unit be in Autofirm mode to achieve optimal results.

### Features and Benefits

- A bilateral side air bolster solution which can enhance your facilities entrapment/risk management program.
- Easy to engage Ready Valve for instant inflation and deflation.
- Transfer friendly-deflate for ease of assisted transfer or when bolsters are not required.
- Unique contoured design allows ease of ingress/egress, while providing additional protection, comfort and supports patient compliance.
- Designed to fit on most therapeutic support surfaces.
- Promotes maximum independence by allowing caregiver to decide when added protection is required.

**Note:** Side bolsters are meant to be used with side rails and to provide a documentable and functional intervention for the risk management issues of falls and entrapment but in no way guarantees the prevention of falls or entrapment occurrences.



# Nursing Procedures

---

## RECOMMENDED LINEN

Special linens are not necessary for the Arise®. While there is no need for a bottom sheet the therapy pad should be covering the therapy cells at all times. The patient should never be lying directly on the therapy cells. Depending upon the patient's specific needs, the following linens may be utilized:

- Draw or slide sheet to aid in positioning and to further minimize friction and shearing.
- Incontinence barrier pad for patients incontinent of urine and/or stool, and patients with heavily draining wounds.
- Add top sheet, blanket and/or bedspread as needed for patient comfort.
- Keep the amount of padding between the patient and bed to a minimum for optimum performance.

## CHANGING THE THERAPY PAD

1. Place the therapy pad over the therapy cells, fitting the corner of the cushions into the corner of the therapy pad. (Similar to a fitted sheet)
2. Zip the therapy pad along each side of the mattress tub.

## PATIENT POSITIONING AND COMFORT

General Repositioning: Patients should be turned and repositioned per individual turning schedule or per facility policy. It may be helpful to activate the Autofirm mode to achieve a firm surface for repositioning purposes. The unit will automatically return to the mode it was in prior to Autofirm in approximately 12 minutes or you can manually return to therapy mode once patient has been repositioned. Unless counter indicated, it is desirable to keep the head of the bed in the low position to provide optimal pressure relief and minimize the risk of shearing injuries.

Elevating Patient into Sitting Position: The special properties of the Arise® therapy pad reduce the opportunity for shear and friction that may occur when raising the head of other beds. As with any surface, sliding can be expected, therefore patients should be repositioned after elevation. The knee gatch or foot of the bed may be elevated first, to help prevent the patient from sliding when the head of the bed is elevated.

## INCONTINENCE

Moisture against the skin surface leads to maceration, or softening of the tissues. To prevent maceration, we recommend you use an incontinence barrier pad to absorb the excess moisture. In the event of incontinence or excess drainage on the therapy pad, you should wipe off the excess fluid from the bed surface.

## SAFETY INFORMATION

### Patient Migration

Specialty bed products are designed to reduce/relieve pressure and the shearing/friction forces on the patient's skin. The risk of gradual movement and/or sinking into hazardous positions of entrapment and/or inadvertent bed exit may be increased due to the nature of these products.

### Traction

With any traction or unstable fractures, maintain physician-directed angle of articulation and guard against risks of patient migration or inadvertent deflation of patient surface.

### Skin Care

Monitor skin conditions regularly, particularly in areas where incontinence and drainage occur or collect, and consider adjunct or alternative therapies for high acuity patients. Early intervention may be essential to preventing serious skin breakdown.

### Bed Height

To minimize the risks of falls or injury the patient surface should always be in the lowest practical position when the patient is unattended. Make sure areas under and around the frame are clear of objects, persons and parts of body before adjusting height.

---

[Return To Table of Contents](#)

# Cleaning, Storage and Care

---

## WARNING

- Unplug the control unit from its power source. Failure to do so could result in personal injury or equipment damage.
- Do not expose the unit to excessive moisture that would allow for liquid pooling. Personal injury or equipment damage could occur.

## CAUTION

- Do not use harsh cleansers/detergents, such as scouring pads and heavy-duty grease removers, or solvents, such as acetone. Equipment damage could occur.
- Do not use any steam cleaning device on the unit.

## CONTROL UNIT

Wipe off dust. If necessary, clean the housing exterior with a disinfectant solution or a mild detergent and a damp cloth. Then wipe dry.

## GENERAL CLEANING

If there is no visible soilage with possible body fluids, we recommend that you clean the mattress system with a mild detergent and warm water. If disinfection is desired, you may use a combination cleanser/disinfectant as explained in “Disinfecting” section.

- Patient care equipment that does not come in contact with mucous membranes or non-contact skin requires low-level disinfection. Wiping surfaces with a properly prepared detergent or disinfectant carries out low level disinfecting.
- Processing of dirty patient care equipment should take place in a designated area away from clean or sterile supplies and food preparation areas.
- Detergent/disinfectants should not be mixed with other germicides or detergents. Using the proper dilution insures the most effective killing power of the disinfectant.
- Wash hands often and well, including after removal of gloves.
- Patient care equipment that is used in isolation areas should be disinfected in accordance with all internal policies and procedures regarding such equipment.

## DISINFECTING

When there is visible soilage, and between patients, it is recommend that the unit and mattress be disinfected with a tuberculocidal disinfectant. Disinfectant should be registered with the Environmental Protection Agency (EPA).

- Use rubber gloves and eye protection.
- Prepare detergent/disinfectant (registered by EPA as hospital disinfectant) solution according to instructions on label for correct use-dilution.
- With support surface deflated, thoroughly wipe down entire mattress, as air cells will lie flat. Be sure to reach all areas underneath and in-between air cells. Allow to air dry.
- If dust or other soiling has accumulated along air hoses, remove using swabs moistened with detergent/disinfectant as necessary. Allow all components to air dry. Wrap mattress in plastic and return to storage area.
- Thoroughly wipe down outside of control unit and allow to air dry. Cover with plastic and return to storage area
- Remove gloves and dispose; wash hands.

# Cleaning, Storage and Care

---

## **THERAPY PAD**

The therapy pad can be wiped down with a disinfectant solution or a mild detergent with a damp cloth. If heavily soiled, the therapy pad can be laundered in a washer and dryer with warm water (no more than 120° Fahrenheit). A non-bleach detergent should be used sparingly. Wipe dry or allow to air dry.

## **STEAM CLEANING**

Do not use any steam cleaning device on the unit. Excessive moisture can damage mechanisms in this unit.

## **FILTER CLEANING**

Check the air filter on the rear of the unit regularly for buildup of dust/dirt. If buildup is visible turn off the control unit and disconnect the power cord from the wall outlet. Remove the filter by grasping the filter pulling outward. Replace with the second supplied filter. Ensure the replaced filter covers the entire filter region.

Hand-wash the removed filter in warm soapy water and allow to air dry. When dry, store the filter in a safe place for the next filter maintenance.

## **STORAGE**

Control Unit: The power cord may be wrapped around the unit for convenience. Wrap the unit in a plastic bag for dust resistance then store the unit in an area appropriate for an electronic medical device.

Support Surface: Gently roll up the support surface, expelling any residual air, for temporary storage. The mattress should be wrapped in plastic and/or a clean bag for storage.

# Preventative Maintenance

---

## MAINTENANCE CHECKLIST

- \_\_\_\_\_ All fasteners secure (reference all assembly drawings).
- \_\_\_\_\_ Hose assembly is not damaged or leaking.
- \_\_\_\_\_ Power switch is working properly.
- \_\_\_\_\_ Power cord is not frayed and is attached to blower assembly.
- \_\_\_\_\_ All electrical connections function properly.
- \_\_\_\_\_ Control Unit buttons function properly.
- \_\_\_\_\_ Plastic on the control unit assembly is not damaged.
- \_\_\_\_\_ Mattress holds air and all straps are intact.
- \_\_\_\_\_ Inspect all product labeling for signs of degradation.

Unit Serial Number:		

Completed by: \_\_\_\_\_

Date: \_\_\_\_\_

# Troubleshooting







---

Problem / Failure	Recommended Action
Therapy surface is not inflating.	<ol style="list-style-type: none"><li data-bbox="578 243 1445 302">1. Ensure the hose connection from the therapy mattress system (mattress) to the control unit is securely connected.</li><li data-bbox="578 310 1445 340">2. Ensure that the control unit is plugged into an A/C outlet.</li><li data-bbox="578 348 1445 407">3. Ensure that the power is <b>not</b> on <i>Standby</i>. If on <i>Standby</i>, press the <b>Power</b> button.</li></ol>
Unable to change therapy mode or adjust comfort control.	<ol style="list-style-type: none"><li data-bbox="578 432 1445 491">1. Make sure the <i>Lockout</i> function is disabled. To disable, press the <b>Up</b> and <b>Down</b> comfort adjust arrows simultaneously.</li></ol>

# Quick Reference Replacement Parts List

## Note

The parts and accessories listed on this page are all currently available for purchase. Please call Stryker Customer Service (800)-327-0770.

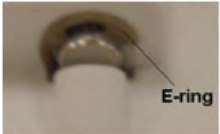
<b>Arise® 1000EX Power Control Unit Replacement Parts</b> <b>2236-100-047</b>		
Part Name	Part View	SYK Part Number
PCB		2236-100-053
Blower assembly		2236-100-038
Bumper Feet: <ul style="list-style-type: none"> <li>• Upper (Square)</li> <li>• Lower (Round)</li> </ul>		2236-100-049 (Upper) 2236-100-050 (Lower)
Fuse, External, 5A (Pkg 1)		2236-100-028
Fuse, Internal, 0.5A (Pkg 1)		2236-100-029
Filter Foam, pkg (1)		2236-100-036
E-Ring		2236-100-039

# Quick Reference Replacement Parts List

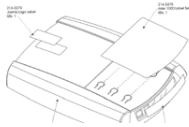

<b>Arise® 1000EX Power Control Unit Replacement Parts</b> <b>2236-100-047</b>		
Part Name	Part View	SYK Part Number
Bed Hook Assembly Kit, includes screws, 2 bed hooks, springs.		2236-100-014
Kit, Power Cord Kit		2236-100-037
Front Label Set, includes 2 front labels		2236-100-064
Gasket		2236-100-051
Power Cord (non detachable)		2236-100-072
Heyco Strain Relief (right angle)		2236-100-066
Fixed Connector Assembly		2236-100-060
Front Enclosure Assembly, includes front cover, insulated front cover, and labels.		2236-100-061
PCB Fasteners (Qty. 8)		2236-100-067
Front Enclosure Fasteners Kit (Qty. 4)		2236-100-068

[Return To Table of Contents](#)

## Quick Reference Replacement Parts List

### Arise® 1000EX Power Control Unit Replacement Parts 2236-100-047

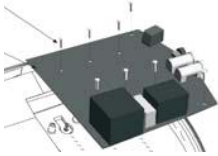

Part Name	Part View	SYK Part Number
PCB with Fasteners Kit		2236-100-070
Blower Wire Harness Assembly		2236-100-071









### Arise® 1000EX Mattress Replacement Parts 2236-100-002 (Reference Only)







Part Name	Part View	SYK Part Number
Air Cell, Cari Rail & Side Extension		2236-100-009
Air Cell, Foot Extension (48")		2236-100-025
Air Cell, Main Support (5x36")		2236-100-008
Back Raise Sensor Assembly (with Plate)		2236-100-026



# Quick Reference Replacement Parts List

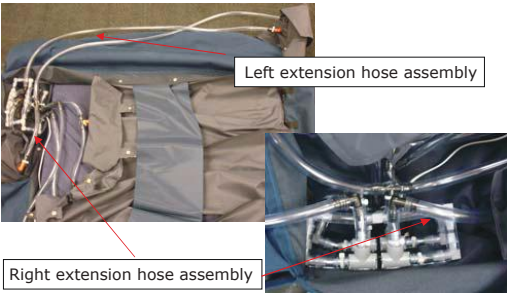
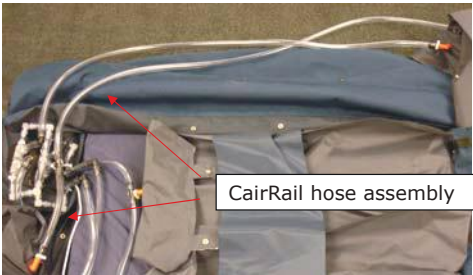

<b>Arise® 1000EX Mattress Replacement Parts 2236-100-002 (Reference Only)</b>		
Part Name	Part View	SYK Part Number
Control Panel		2236-100-013
Control Panel Knob		2236-100-056
External Hose Assembly		2236-100-007
External Hose Cover, Bariatric		2236-100-023
Foam Safety Mattress, (3")		2236-100-012
Hose Clamp		2236-100-027
Loop Strap		2236-100-011
Mattress Tub (Bottom Cover)		2236-100-024

# Quick Reference Replacement Parts List

<b>Arise® 1000EX Mattress Replacement Parts</b> <b>2236-100-002 (Reference Only)</b>		
Part Name	Part View	SYK Part Number
Therapy Pad (Top COVer)		2236-100-006
Air Cell, Left CairRail and Side Extension		2236-100-055
Connector Free		2236-100-021
Internal Hose Assembly	<div style="border: 1px solid black; padding: 5px;"> <p>Foot section hose assembly</p> <p>Seat section hose assembly</p> <p>Head section hose assembly</p>  <p>Includes tubing that connects to the cells, barbed tees, and barbed elbows. Does not include air cells (with red connector) or herbie clamps.</p> </div>	<p><u>Head Section:</u> 2236-100-074</p> <p><u>Seat Section:</u> 2236-100-075</p> <p><u>Foot Section:</u> 2236-100-076</p>
Internal Hose Assembly	<div style="border: 1px solid black; padding: 5px;"> <p>Left extension hose assembly</p>  <p>Right extension hose assembly</p> </div>	<p><u>Right Extension:</u> 2236-100-077</p> <p><u>Left Extension:</u> 2236-100-078</p>
Internal Hose Assembly	<div style="border: 1px solid black; padding: 5px;">  <p>CairRail hose assembly</p> </div>	<p><u>CairRails:</u> 2236-100-079</p>

[Return To Table of Contents](#)

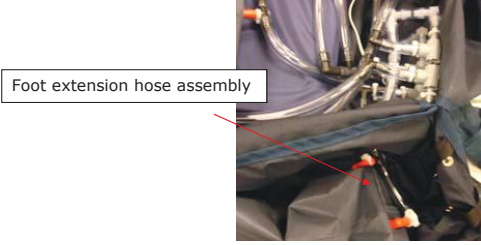
# Quick Reference Replacement Parts List

<b>Arise® 1000EX Mattress Replacement Parts</b> <b>2236-100-002 (Reference Only)</b>		
Part Name	Part View	SYK Part Number
Internal Hose Assembly		<u>Foot Extension:</u> 2236-100-080
Internal Hose Assembly		<u>All Sections:</u> 2236-100-057

# Warranty

---

## LIMITED WARRANTY

The Arise® 1000EX mattress system is guaranteed for a period of one year from the date of delivery, against defects in materials and workmanship, under normal use and service. This one-year warranty includes all mechanical and electrical components. Steel structural components on beds are covered under warranty for a period of 10 years from the date of delivery. Welds are covered under warranty for the lifetime of the product.

Damage caused by use in unsuitable environmental conditions, abuse or failure to maintain the product in accordance with user and service instructions is not covered. Any alteration, modification, or repair unless performed by or authorized in writing by Stryker Medical, will void this warranty. Damages arising from improper use will not be covered under this warranty.

Improper use is defined as, but not limited to, those caused by

- Burns
- Use of improper chemical agents
- Needle punctures, cuts or abrasions
- Excessing loads
- Staining
- Negligent or excessive usage
- Improper maintenance, handling and/or cleaning
- Failure to use in the manner indicated in this user manual

## PARTS

The Arise® 1000EX mattress system contain various parts that wear from normal use. Stryker Medical's obligation under this warranty is limited to supplying replacement parts, servicing or replacing, at its option, any product which is found by Stryker Medical to be defective.

Warranty replacement parts are covered by the terms of this warranty until the product's original one-year warranty period expires. Part replacements under warranty may be requested to be returned back to the manufacturer. When requested by Stryker Medical, parts must be returned for inspection at the customer's expense. Credit will be issued only after inspection.

## SERVICE

Most service requests can be handled by the facility Maintenance Department with assistance from the Stryker Medical Technical Support Service Department. Most parts requested can be shipped next day air at the customer's expense. Should a technician be required, one will be provided by Stryker Medical, at our discretion. Only the Stryker Medical Technical Support Service Department can dispatch authorized technicians. This warranty is extended to the original purchaser of the equipment.

For further service needs please call Stryker at 1-800-327-0770.

\* Does not include maintenance due to abuse or for any disposable items. Stryker reserves the right to change options without notice.

Detach Here

Detach Here

## Features Overview

- Low air-loss
- Pressure redistribution
- Pulsation therapy
- Patient position sensor

## Arise™ 1000EX Mattress Replacement

- Weight capacity 1000 lbs.
- Width: 36", 42", 48"
- Length: 80", 88"
- Height: 8.5"

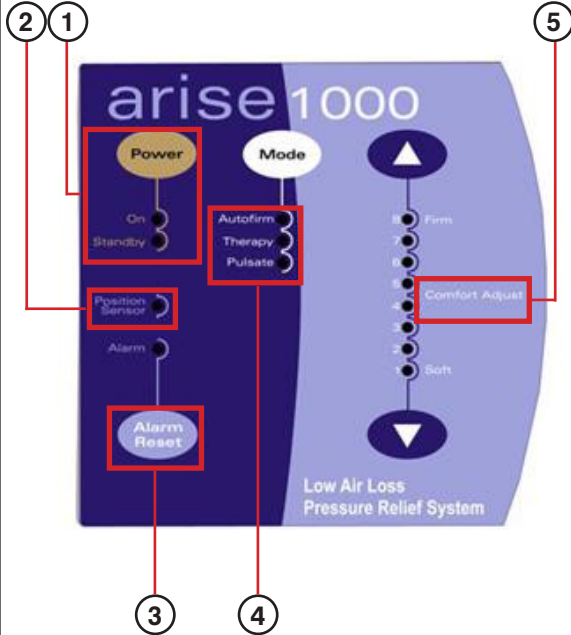

1. **Power:** Pressing "Power" turns surface on/off.
  - **On:** Surface has full power; after 10 minutes of inactivity the control module will lock out and the "On" button will flash green to help prevent unwanted changes to surface – to unlock press the up and down arrows on "Comfort Adjust" simultaneously.
  - **Standby:** Surface has lost power or has been unplugged.
2. **Position Sensor:** Automatically activated when HOB is raised above 28°; pumps more air into sacral region to help prevent bottoming out.
3. **Alarm Reset:** Alarm will sound when there has been a power interruption; press "Alarm Reset" to disable alarm.
4. **Therapy Modes:** to set therapy mode, press "Mode" until light illuminates next to selected mode.
  - **Autofirm:** Max inflates the surface to aid caregiver in boosts and transfers; automatically returns to the mode it was in prior to "Autofirm" in approximately 12 minutes.
  - **Therapy:** Low air-loss therapy.
  - **Pulsate:** Initiates pulsation therapy to promote lymphatic flow; the pulsation wave starts at the head end and gradually moves toward foot end and then cycles back up; pulsation therapy will continue until mode is changed.
5. **Comfort Adjust:** Default setting is 5; adjust firmness according to patient weight; the heavier the patient, the higher the setting.

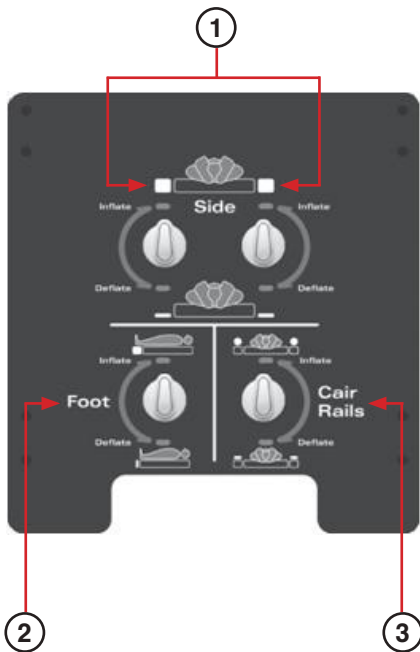

1. **Inflatable Width Air Bladders**
  - To activate the width air bladders, turn the white knob to "Inflate".
  - The air bladder will expand 6" on each side.
  - Air bladders can be inflated simultaneously or independently.
  - To deflate, turn the knob towards "Deflate".
2. **Inflatable Length Air Bladder**
  - To activate the length air bladders, turn the white knob to "Inflate".
  - The air bladder will expand 8"
  - To deflate, turn the knob towards "Deflate".
3. **CairRails™**
  - Provides 2" of additional support along the surface perimeter, helping keep the patient centered and their limbs from resting against the side rail.
  - To activate turn the white knob towards "Inflate".
  - To let air out of the CairRails, turn the white knob towards "Deflate".

### To connect hose/CPR:



Insert hose into air blower. Make sure tabs snap securely in place.

### To disconnect hose/CPR:



Squeeze tabs on the size and pull down.





UNITED STATES  
Stryker Medical  
3800 E. Centre Ave.,  
Portage, Michigan USA  
49002

CANADA  
Stryker Canada  
45 Innovation Drive  
Hamilton, Ontario Canada  
L9H 7L8

EC	REP
----	-----

**European Representative**  
Stryker France  
ZAC Satolas Green Pusignan  
Av. De Satolas Green  
69881 MEYZIEU Cedex  
France

**stryker**<sup>®</sup>