

Pulsate™



User Manual

Doc. #: _____ Rev. Date: _____ Rev.: _____

Table of Contents

Introduction	2
Product at a Glance	3
Symbols	5
Labels	6
Safety Instructions	8
Specifications.....	12
EMC Information	14
Unpacking Instructions	18
Setup Instructions	19
Operating Instructions	20
Cleaning Instructions	23
Maintenance	26
Troubleshooting	28
Frequently Ordered Parts	29
Storage and Disposal.....	30
Warranty Information	31

Introduction

Intended Use

Pulsate™ is indicated for the prevention and treatment of pressure injuries, the treatment of severe or extensive burns, and to aid in circulation.

Purpose of the Device

Pulsate™ is a therapeutic support surface that provides immersion for pressure redistribution. It offers two therapy modes: pulsation and static (immersion), both with low air loss.

Pulsate can be used for patients with spinal cord injury once the acute injury has been stabilized and these patients have been assessed and cleared by the appropriate physician. Pulsate is not recommended for use by patients with unstable spinal fractures.

The selection of a pressure redistribution surface should be based on each individual patient's clinical condition, diagnosis and/or co-morbidities. The choice and use of a support surface is one factor in a holistic program of wound prevention and treatment.

Device Information

Pulsate™ Low Air Loss Mattress System is comprised of a specialized inflatable air bladder (air mattress) and an electrically powered control unit.

Pulsate is a specialized, multi-cell air mattress sized to fit a standard hospital bed frame. The air mattress serves as a replacement to the original mattress and is equipped with 6 air tubes with connectors that connect to the control unit. The control unit is a self-contained, totally enclosed module that hangs by hinged hooks on the footboard of the bed.

If the footboard is too wide, hang a control unit hanger bar on the footboard. If no hanger bar is available, use best judgment on control unit placement. Do not place control unit under the bed.

The control unit is provided with a detachable hospital grade electrical cord and has a control panel with selector switches and indicator lights. The switches and indicators are protected under a flexible membrane to keep liquids out spills and make cleaning easier. Inside the control unit is a variable output blower and manifold that allow the air mattress to operate in a static (immersion) mode or provide pulsation pressure variations within the mattress. There is also a printed circuit board which operates the electrical controls.

General Information

- Authorized user is defined as an adult.
- Read and completely understand the manual before use.
- DO NOT modify this equipment without authorization from the manufacturer.
- Only use Agiliti accessories that are specific to Pulsate.
- At certain intervals, maintenance of this product is required and must be performed by authorized personnel only.
- Retain this manual for future use and maintenance.
- Patients, or users, should be risk assessed to ensure they are able to understand this manual and operate the Pulsate safely without risk to themselves or others.

Symbols, definitions, and fonts are used throughout this manual to aid user readability and understanding of content.

- Standard Text: Used for regular information.
- **Bold Text:** Emphasizes a word or phrase.
- **NOTE:** Sets apart special information or important instruction clarification.

Product at a Glance

Control Unit

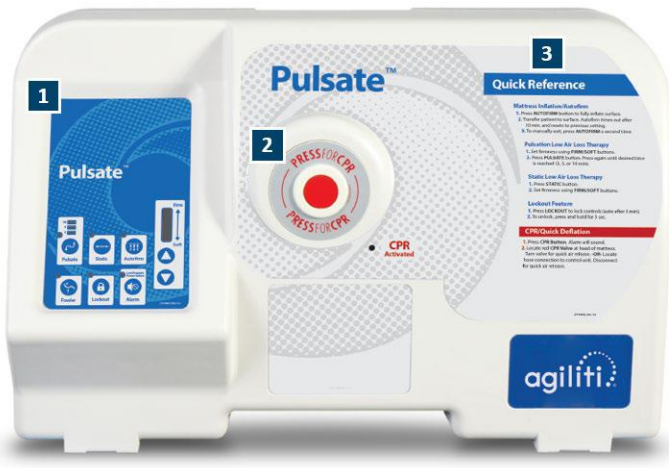

1. Control unit keypad
2. CPR button
3. Quick Reference instructions

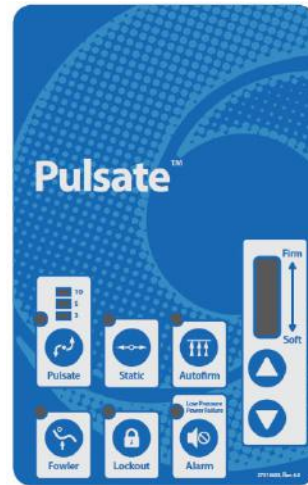

1. Control unit keypad

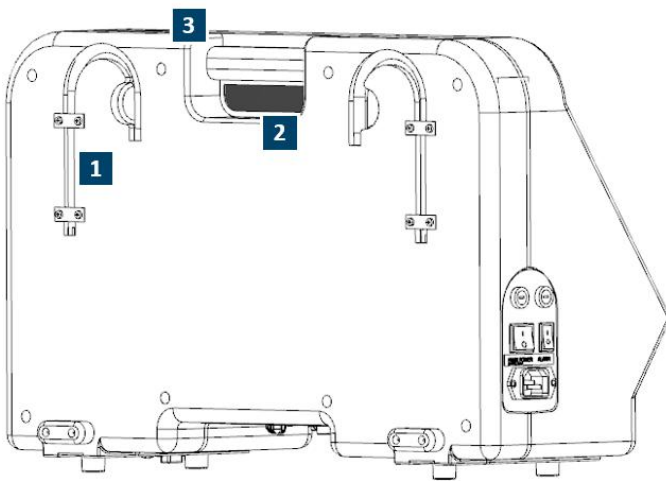

1. Mounting hooks
2. Foam filter/HEPA filter
3. Carrying handle

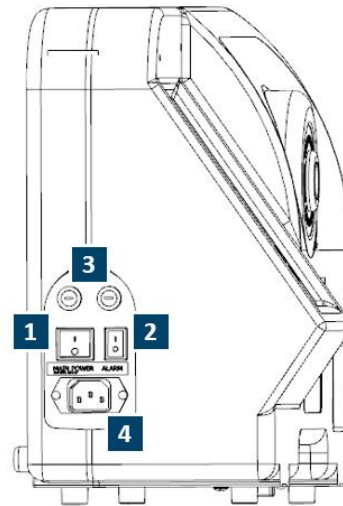

1. Power switch
2. Alarm switch
3. Fuses
4. Power cord receptacle

Product at a Glance

Mattress



1. Mattress



1. Serial number location

Symbols

Symbol	Description
 <p>ETL CLASSIFIED C ETL US LISTED Intertek</p>	<p>Certification:</p> <p>Indicates device has been independently tested and meets the published safety standard(s).</p>
 <p>TYPE B</p>	<p>Device Type:</p> <p>Indicates a Type B device properly protected from electrical shock.</p>
	<p>Follow User Manual:</p> <p>Indicates mandatory action to read and fully understand these instructions prior to use.</p>
	<p>Accompanying Documents:</p> <p>Read and fully understand all accompanying documents for Pulsate™ before use.</p>
	<p>Electrical Shock Hazard Warning:</p> <p>Symbol alerts user to the presence of electrical shock hazards. It is important to follow all instructions and special procedures to avoid electrical shock to the operator, caregiver, and/or patient.</p>
	<p>Contraindication:</p> <p>Symbol alerts user to possible condition or circumstance which makes a particular treatment or procedure potentially inadvisable. Disregarding a contraindication could result in patient and/or user injury, as well as damage to equipment.</p>
	<p>Warning/Caution:</p> <p>Symbol alerts user to the presence of important operating, maintenance, or servicing instructions. Disregarding a warning could result in patient and/or user injury, as well as damage to equipment.</p>

Labels

Manufacturer's Label

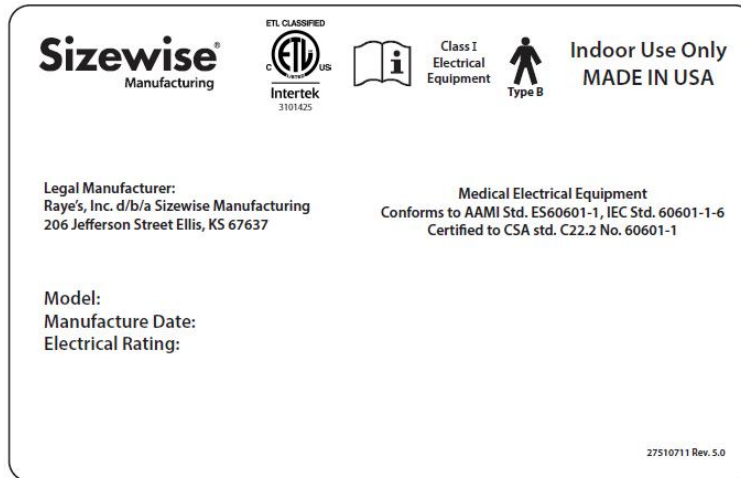

Label

Description

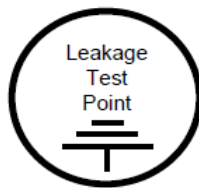

Label indicates the location of the leakage test point screw.



Label indicates the location and specifications of fuses.

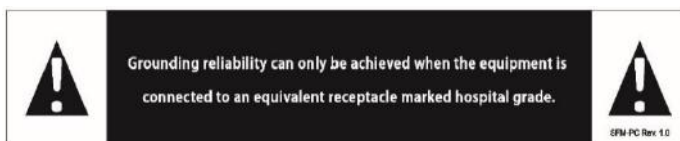

Label on power cord explaining the requirement for the power cord to be connected to hospital grade outlets only.



Label indicates mains power switch and alarm power switch locations.

Labels

Label	Description
-------	-------------



Label relaying information on hazards related to environmental requirements for transport and storage.

Label located on packaging.

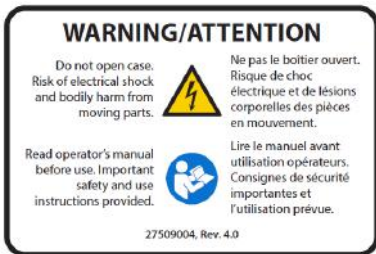

Label relays important warning for hazards related to electrical shock and bodily harm.

Do not open control unit case.

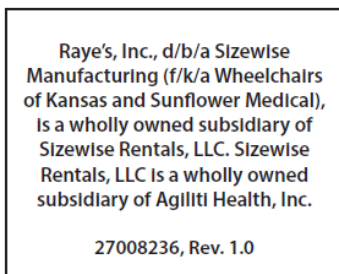

Label indicates and explains legal entity relationship.

Safety Instructions



WARNING: Bed rail entrapment is a serious health risk that can result in serious injury or even death. Agiliti recommends the care provider be mindful of the FDA guidelines relevant to bed rail entrapment, as serious injury can result. These guidelines can be found on the FDA website. When using an Air Therapy system the care provider is responsible for ensuring the mattress properly fits the bed frame. It is also the care provider's ultimate decision whether or not to use bed rails with the patient.

Seven Zones of Bed Rail Entrapment

If the patient would have any clinical conditions that could result in risk of falling or improperly lying-in bed, the bed should be left at its lowest setting and in flat position when not attended. Agiliti recommends the use of bed rails if they are available. There are seven zones of bed rail entrapment.



Zone 1:
Within the Rail

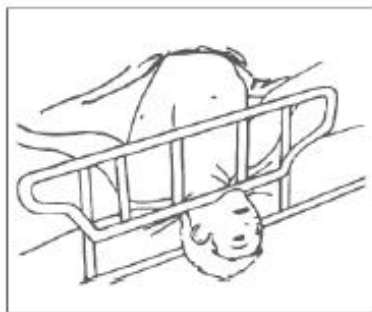
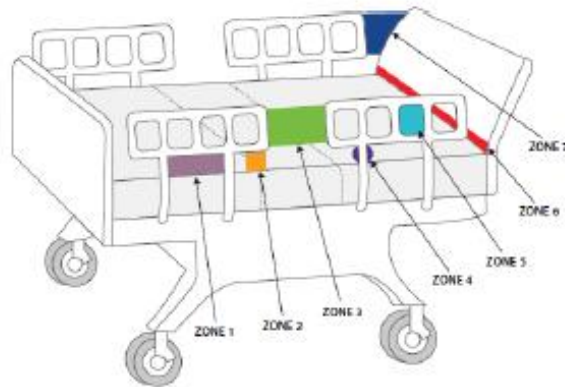

Zone 2:
Under the Rail, Between the Rail Supports, or Next to a Single Rail Support



Zone 3:
Between the Rail and the Mattress

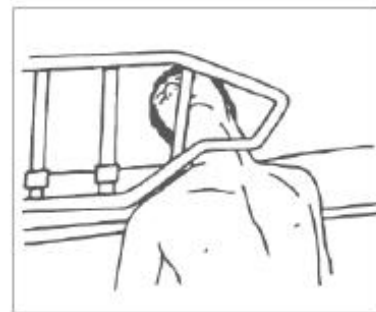

Zone 4:
Under the Rail, at the Ends of the Rail

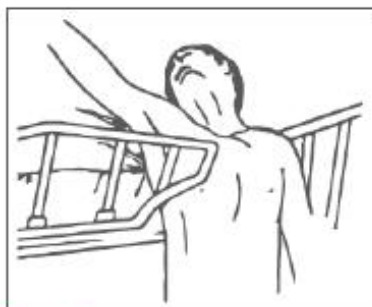

Zone 5:
Between Split Bed Rails

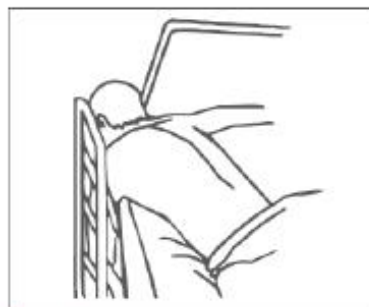

Zone 6:
Between the End of the Rail and the Side Edge of the Head or Footboard

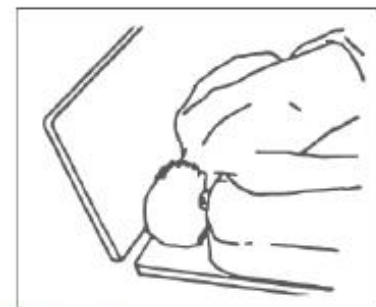

Zone 7:
Between the Head or Footboard and the Mattress End

Reference: Hospital Bed System Dimensional and Assessment Guidance to Reduce Entrapment. (2006, Mar. 10). U.S. Health and Human Services Food and Drug Administration Center for Devices and Radiological Health. Retrieved from <https://www.fda.gov/downloads/medicaldevices/deviceregulationandguidance/guidancedocuments/ucm072729.pdf>

Safety Instructions

Only authorized users should operate Pulsate™. A thorough understanding of the Pulsate user manual is required prior to use. Follow the instructions contained in this manual carefully. Use Pulsate only if it is in proper working order. The terms Warning and Caution are used frequently throughout this manual. A clear and concise understanding is required of these two terms.



CONTRAINDICATION: Indicates important information that may be contradictory to the product instructions, which if not understood, could cause serious injury.



ELECTRICAL SHOCK HAZARD WARNING: This symbol is intended to alert the user to the presence of electrical shock hazards. It is important to follow all instructions and special procedures to avoid electrical shock to the operator, care provider, and/or patient.



WARNING: Indicates a potentially dangerous situation, which if not avoided, could result in injury ranging from moderate to serious severity up to and including death.



CAUTION: Indicates a potentially dangerous situation, which if not avoided, could result in injury ranging from minor to moderate severity.

Electrical Shock Hazards



ELECTRICAL SHOCK HAZARD WARNING: To avoid risk of electric shock or injury, only use manufacturer's approved power cord.



ELECTRICAL SHOCK HAZARD WARNING: Inappropriate handling of the power supply cord, (e.g. by kinking, shearing, other mechanical damages) is hazardous.



ELECTRICAL SHOCK HAZARD WARNING: Before any cleaning and disinfection procedures are performed, unplug power cord from outlet to eliminate possibility of electrical shock.



ELECTRICAL SHOCK HAZARD WARNING: Electrical shock may occur when plugging the Pulsate™ optional air pump into the wall outlet. Use ONLY grounded or hospital-grade outlets.



ELECTRICAL SHOCK HAZARD WARNING: To avoid electrical shock, DO NOT open the control unit. Refer servicing to qualified personnel only.

Safety Instructions

Warnings



WARNING: Medical equipment should not be used, stacked, or located on or around equipment that may create electromagnetic interferences.



WARNING: Using other manufacturer's cables and accessories may affect EMC performance. Unauthorized use of these items will void warranty and could result in patient and/or user injury as well as damage to equipment or other property.



WARNING: The use of cables or accessories other than those for which the control unit was designed or tested can significantly degrade emissions and immunity performance.



WARNING: Bed rail entrapment is a serious health risk that can result in serious injury or even death. Agiliti recommends the care provider be mindful of the FDA guidelines relevant to bed rail entrapment, as serious injury can result. These guidelines can be found on the FDA website. When using an Air Therapy system the care provider is responsible for ensuring the mattress properly fits the bed frame. It is also the care provider's ultimate decision whether or not to use bed rails with the patient.



WARNING: It is recommended that gloves and protective clothing be worn at all times during cleaning and disinfecting.



WARNING: DO NOT autoclave.



WARNING: (120V unit) Make sure the power cord is plugged into a properly grounded hospital grade 120V A/C outlet.

Safety Instructions

Cautions



CAUTION: Only authorized personnel should engage in the troubleshooting process. Troubleshooting by unauthorized persons could result in personal injury or equipment damage.



CAUTION: It is recommended that gloves and protective clothing be worn at all times during cleaning and disinfecting.



CAUTION: Keep out of direct sunlight.



CAUTION: DO NOT expose to temperatures below 0°F (-18°C) or above 95°F (35°C).



CAUTION: DO NOT expose to moisture or areas of humidity greater than 95%.



CAUTION: Beware of Electromagnetic Interference from Radio Wave Sources such as: Hand-held portable transceivers with the antenna mounted directly to the transmitting unit including citizen band

(CB) radios, “walkie-talkies, security, fire and police transceivers, cellular telephones and other personal communication devices.



CAUTION: The mattress requires regular maintenance to ensure performance and avoid premature wear, damage and injury.

Specifications

Control Unit	
Mode of Use	For Indoor Use Only
Duty Cycle	Continuous
Control Unit Dimensions (LxWxH)	7.5" (19cm) x 18.5" (47cm) x 12" (30.5cm)
Control Unit Weight	16 lb. (7.26kg)
Operating Temperature	-18°C to 35°C (0°F to 95°F)
Functions	
Pulsating Low Air Loss	3,5, or 10 minutes
Liters of Air Per Minute	1,740 LPM
Alarms	Power Failure
	Low Pressure
	CPR
Electrical	
Power Requirements	120V AC 60 Hz 6.3A Maximum
Electric Shock Protection	Class I
Degree of Shock Protection	Type B
Maximum Relative Humidity	95%
Storage Temperature	-18°C to 35°C (0°F to 95°F)
Environmental Conditions	Product must be stored and transported in packaging free of moisture and dust.
User Serviceable Parts	Hooks, hook brackets, absorber pad, power cord, fuses, and filters.
Power Cord	16' (5m) detachable with hospital grade plug.
Fuses	T 6.3A 250V AC (5mm x 20mm)

Specifications

Surfaces				
Air Cells (qty.)		20		
Air Cell Zones (qty.)		1		
Top Cover		Polycarbonate 4-Way Stretch		
Standard 35"				
Surface Weight		19 lb. (8.62kg)		
Safe Working Load		600 lb. (272.35kg)		
Maximum Patient Weight		550 lb. (249.48kg)		
Air Cell Height	Base (foam)	Overall Height	Width	Length
6" (15.24cm)	2" (5.08cm)	8" (20.32cm)	35" (88.9cm)	82" (208.3cm)
Bariatric 39"				
Surface Weight		25 lb. (11.33kg)		
Safe Working Load		1000 lb. (453.59kg)		
Maximum Patient Weight		950 lb. (430.92kg)		
Air Cell Height	Base (foam)	Overall Height	Width	Length
8" (20.32cm)	1" (2.54cm)	9" (22.86cm)	39" (99cm)	82" (208.3cm)
Bariatric 42"				
Surface Weight		31 lb. (14.06kg)		
Safe Working Load		1000 lb. (453.59kg)		
Maximum Patient Weight		950 lb. (430.92kg)		
Air Cell Height	Base (foam)	Overall Height	Width	Length
8" (20.32cm)	1" (2.54cm)	9" (22.86cm)	42" (106.7cm)	82" (208.3cm)
Bariatric 48"				
Surface Weight		37 lb. (16.8kg)		
Safe Working Load		1000 lb. (453.59kg)		
Maximum Patient Weight		950 lb. (430.92kg)		
Air Cell Height	Base (foam)	Overall Height	Width	Length
8" (20.32cm)	1" (2.54cm)	9" (22.86cm)	48" (121.9cm)	82" (208.3cm)

EMC Information



WARNING: Medical equipment should not be used, stacked, or located on or around equipment that may create electromagnetic interferences.



WARNING: Using other manufacturer's cables and accessories may affect EMC performance. Unauthorized use of these items will void warranty and could result in patient and/or user injury as well as damage to equipment or other property.



WARNING: The use of cables or accessories other than those for which the control unit was designed or tested can significantly degrade emissions and immunity performance.

Pulsate™ has been tested for compliance with the EMC requirements. The guidelines in this section will help to ensure the medical equipment will meet the requirements of the standard.

Emissions

This control unit has been type tested and has passed the requirements of CISPR 11. Observe the following recommendations to minimize radio frequency emissions in this section and the Electromagnetic Interference section.

The control unit is intended for use in the electromagnetic environment specified below. The customer or user of this control unit should ensure that it is used in such an environment.

Table 201 Guidance and Manufacturer's Declaration - Emissions All Equipment and Systems

Emissions Test	Compliance	Electromagnetic Environment Guidance
RF Emissions CISPR 11	Group 2	The control unit must emit electromagnetic energy in order to perform its intended function. Nearby electronic equipment may be affected.
RF Emissions CISPR 11	Class A	The control unit is suitable for use in all establishments, including domestic establishments and those directly connected to the public low-voltage power supply network that supplies buildings used for domestic purposes.
Harmonics IEC 61000-3-2	Class A	
Flicker IEC 61000-3-3	Complies	

All pins of connectors have passed ESD testing.

List of Cables & Accessories

Replacement parts, such as cables and accessories, must be purchased through Agiliti to ensure proper compliance requirements.

EMC Information

Immunity

This control unit has been stringently tested for susceptibility to electromagnetic radiation over the frequency range 80 MHz to 2.5 GHz. The test was conducted on this control unit and passed the requirements of IEC 60601-1-2:2007.

The control unit is intended for use in the electromagnetic environment specified below. The customer or user of the control unit should ensure that it is used in such an environment.

Table 202 Guidance and Manufacturer's Declaration - Immunity All Equipment and Systems

Immunity Test	IEC 60601 Test Level	Compliance Level	Electromagnetic Environment Guidance
ESD IEC 61000-4-2	±6kV Contact ±8kV Air	A	Floors should be wood, concrete or ceramic tile. If floors are synthetic, the r/h should be at least 30%
EFT IEC 61000-4-4	±2kV Mains ±1kV I/Os	A	Mains power quality should be that of a typical commercial or hospital environment.
Surge IEC 61000-4-5	±1kV Differential ±2kV Common	A	Mains power quality should be that of a typical commercial or hospital environment.
Voltage Dips/Dropout IEC 61000-4-11	>95% Dip for 0.5 Cycle 60% Dip for 5 Cycles 30% Dip for 25 Cycles >95% Dip for 5 Seconds	A	Mains power quality should be that of a typical commercial or hospital environment. If the user of the control unit requires continued operation during power mains interruptions, it is recommended that the control unit be powered from an uninterruptible power supply or battery.
Power Frequency 50/60Hz Magnetic Field IEC 61000-4-8	3A/m	A	Power frequency magnetic fields should be that of a typical commercial or hospital environment.

EMC Information

Table 204 Guidance and Manufacturer's Declaration - Immunity Equipment and Systems which are NOT Life-supporting

Immunity Test	IEC 60601 Test Level	Compliance Level	Electromagnetic Environment Guidance
Conducted RF IEC 61000-4-6 Radiated RF IEC 61000-4-3	3 VRMS .15 MHz to 80 MHz 3 V/m 80 MHz to 2.5 GHz	$(V1) \text{ VRMS} = 3$ $(E1) \text{ V/m} = 3$	Portable and mobile communications equipment should be separated from the control unit by no less than the distances calculated/listed below: $D = (3.5/V1) (\text{SQRT } P)$ $D = (3.5/E1) (\text{SQRT } P)$ 80 to 800 MHz $D = (7/E1) (\text{SQRT } P)$ 800 MHz to 2.5 GHz Where P is the max power in watts and D is the recommended separation distance in meters. Field strengths from fixed transmitters, as determined by an electromagnetic site survey, should be less than the compliance levels (V1 and E1). Interference may occur in the vicinity of equipment containing a transmitter.

EMC Information

Equipment and Systems which are NOT Life-supporting Recommended Separation Distances for the control unit

The control unit is intended for use in the electromagnetic environment in which radiated disturbances are controlled. The customer or user of the control unit can help prevent electromagnetic interference by maintaining a minimum distance between portable and mobile RF Communications Equipment and the control unit as recommended below, according to the maximum output power of the communications equipment.

$$D = (3.5/\sqrt{P}) \text{ (SQRT P)}$$

$$D = (3.5/E1) \text{ (SQRT P)}$$

80 to 800 MHz

$$D = (7/E1) \text{ (SQRT P)}$$

800 MHz to 2.5 GHz

Table 206 Recommended Separation Distances between portable and mobile RF Communications equipment and the control unit.

Compliance Level	Cond RF 3	Rad RF-800MHz 3	Rad RF - 2.5GHz 3
0.01	0.12	0.12	0.23
0.1	0.37	0.37	0.74
1	1.17	1.17	2.33
10	3.69	3.69	7.38
100	11.67	11.67	23.33

Unpacking Instructions



WARNING: (120V unit) Make sure the power cord is plugged into a properly grounded hospital grade 120V A/C outlet.



CAUTION: Keep out of direct sunlight.



CAUTION: DO NOT expose to temperatures below 0°F (-18°C) or above 95°F (35°C).



CAUTION: DO NOT expose to moisture or areas of humidity greater than 95%.



CAUTION: Beware of Electromagnetic Interference from Radio Wave Sources such as: Hand-held portable transceivers with the antenna mounted directly to the transmitting unit including citizen band (CB) radios, "walkie-talkies, security, fire and police transceivers, cellular telephones and other personal communication devices.

NOTE: Some cellular telephones and similar devices transmit signals while they are ON, even when not being used.

General

The two principal components of the Pulsate™ system are a specialized air inflatable bladder (Air Mattress) and an electrically powered control unit.

Instructions

Remove product from packing material and examine for shipping damage. If damage is detected, contact the freight company and file a damage complaint immediately.

Parts:

- Control Unit
- Detachable power cord
- Low Air Loss Mattress Replacement with Mattress Cover

Setup Instructions



ELECTRICAL SHOCK HAZARD WARNING: Electrical shock may occur when plugging the Pulsate™ optional air pump into the wall outlet. Use **ONLY** grounded or hospital-grade outlets.

Pulsate™ can be placed on any conventional medical bed, including those used in hospitals, nursing homes or a homecare. The original mattress should be removed and stored in an appropriate place. The following steps should be completed in installing the system:

1. Remove standard mattress from bed.
2. Replace with Pulsate™ mattress. (Be sure air hoses are at the foot end of the bed).
3. Strap Pulsate air mattress to bed frame on all four sides with straps provided.
4. Place control unit on the footboard using the two hinged hooks located on the back of the unit.
5. Use power cord to connect the control unit and medical grade power outlet.
6. Align master shape on mattress quick connector to same shape on control unit.
7. Apply upward pressure and twist counterclockwise until all three tabs are seated in slots.
8. Visually inspect connection to ensure connector will not leak air.

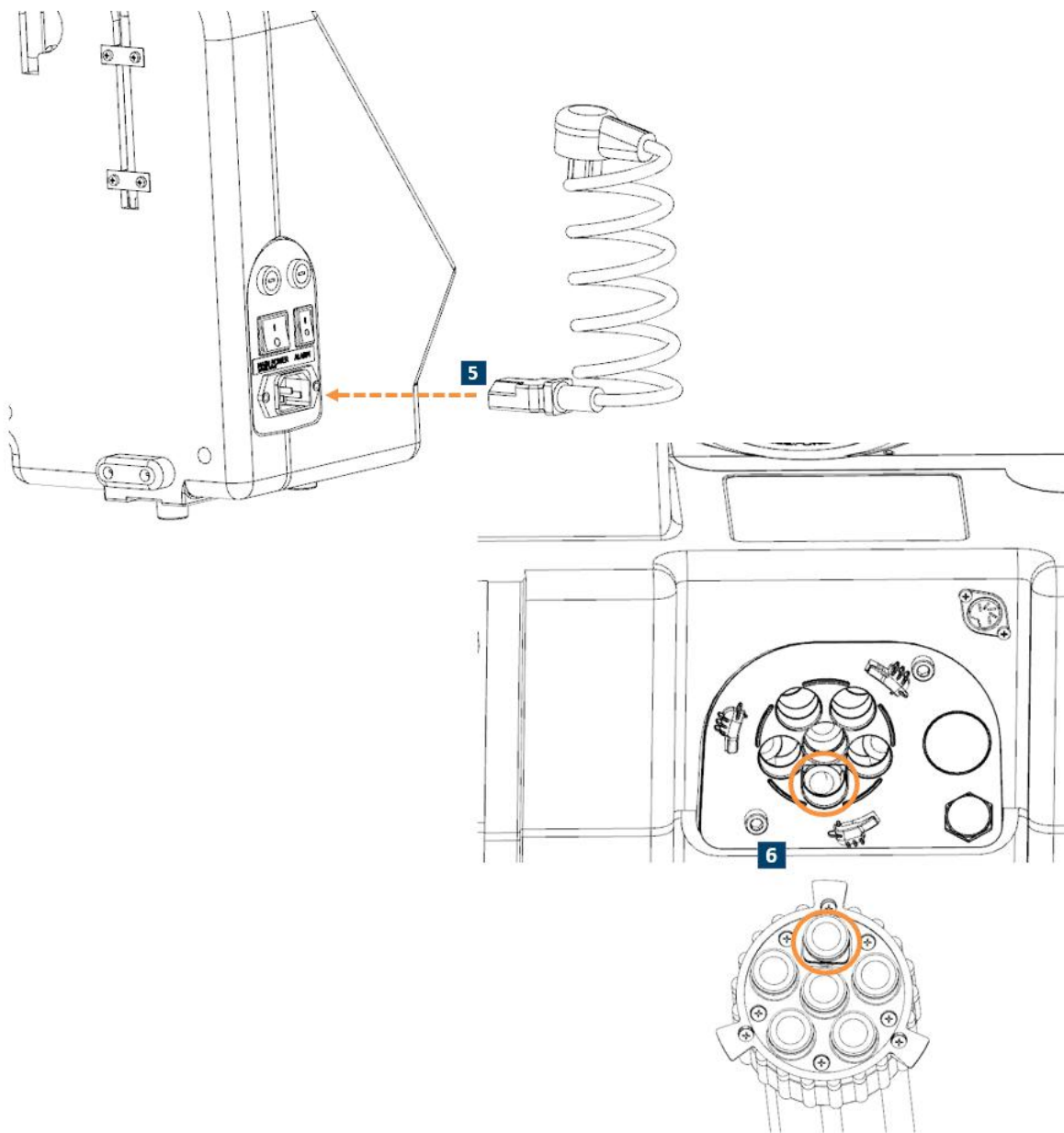

Operating Instructions



WARNING: (120V unit) Make sure the power cord is plugged into a properly grounded hospital grade 120V A/C outlet.

1. Turn the master power switch ON, located on the side of the unit.
2. Press the AUTOFIRM button for quick inflation. (See keypad quick reference section)
3. Place patient on bed after inflation to ensure air cells do not become twisted or kinked.

After inflation, press AUTOFIRM button again to exit Autofirm mode. (If control unit is left in Autofirm mode for 10 minutes, it will automatically return to previous mode of operation).

Modes of Operation

NOTE: See Keypad Quick Reference (see table of contents) for further illustration.

- 1) Static (Immersion) Mode
 - a) Press the STATIC button.
 - b) Set desired firmness with the SOFT and FIRM buttons on the control panel.
- 2) Pulsate Mode
 - a) Press the PULSATE button to activate Pulsate mode.
 - b) Press the PULSATE button until desired time is shown by the indicator lights above the button. (Cycle times are preset at 3, 5 and 10 minutes).
- 3) Fowler Mode
 - a) Manual Fowler
 - i) When elevating the head section of the bed, press the FOWLER button to increase airflow to the seat area of the mattress.
 - ii) After the head section of the bed is lowered, press the FOWLER button to exit Fowler mode.
- 4) Auto Fowler (if equipped)
 - a) When elevating the head section of the bed, FOWLER mode will automatically activate. Fowler mode will automatically deactivate when the head section of the bed is lowered.
- 5) Lockout Feature
 - a) After 3 minutes of inactivity to control unit settings, the lockout feature will activate automatically.
 - b) Press and hold the LOCKOUT button to exit lock-out hold approximately 3-5 seconds).

Operating Instructions

CPR Function

1. CPR Function (Push Button or Dial) is located on the front center of the control unit.
 - a. CPR button
 - i. Press and release the CPR button (illustration below) to activate the CPR function. -CPR alarm and light will come on. After 10 seconds the alarm will beep every 5 seconds and the light will start flashing-
 - ii. Press and release CPR button again to exit; control unit will return to the previous mode of operation.

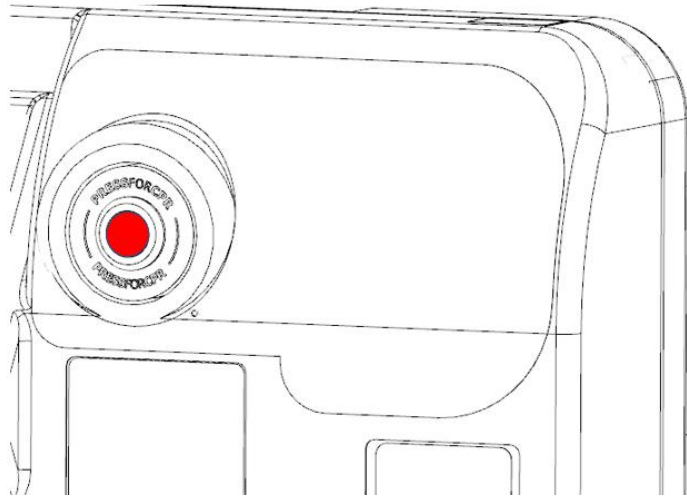

- b. CPR Dial (below)
 - i. Turn the Control Unit's CPR Dial clockwise to the CPR ON position.
 - ii. After mattress deflation is complete, turn off the Control Unit.



The CPR Dial is located on the front of the unit next to the control panel.

IN THE EVENT THE ALARM SOUNDS, THE INDICATOR LIGHT WILL APPEAR INDICATING EITHER POWER FAILURE OR LOW PRESSURE. SEE THE TROUBLESHOOTING SECTION INDICATED IN THE TABLE OF CONTENTS.

Operating Instructions

Keypad

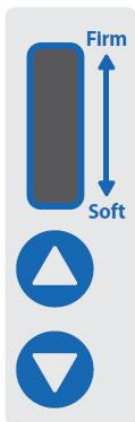
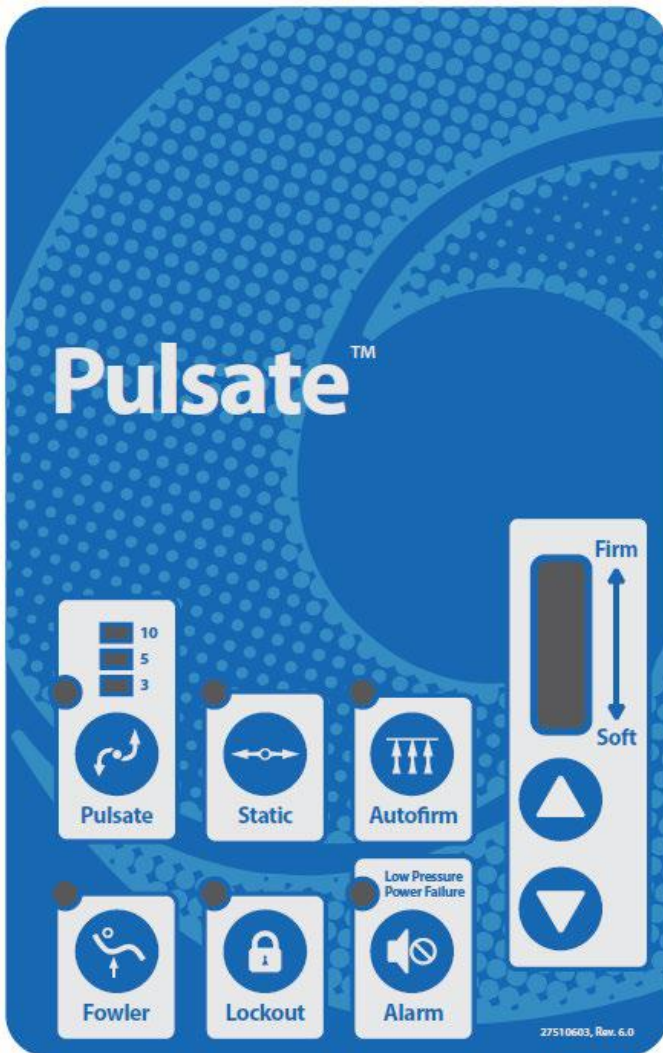

Surface comfort level adjustable from 1-10. 1 is softest, 10 is firmest.



Enables static (immersion) low air loss therapy with pressure sensors regulating airflow.



Use when head section of bed is elevated. Increases airflow to mattress.



Locks all functions. To unlock, press and hold for 3 seconds.



Enables pulsation with pressure sensor regulating airflow. Pulsate cycle times are preset at 3, 5, and 10 minutes.



Silences the audible alarm. Light will remain illuminated until alarm condition is corrected.



Quickly inflates mattress to maximum firmness. Automatically times out in 10 minutes. To manually exit press a second time

NOTE: This chart is to be used as a reference ONLY. Final patient settings must be completed by the patient's caregiver.

Cleaning Instructions



WARNING: It is recommended that gloves and protective clothing be worn at all times during cleaning and disinfecting.



WARNING: DO NOT autoclave.

NOTE: Improper cleaning, rinsing or the incorrect use of cleaning agents can lead to premature fabric discoloration and breakdown of the fabric's fluid-resistance, stain-resistance and fabric strength. Properly rinsing all cleaning agents and disinfecting chemicals is a critical step in extending the life of covers on medical mattresses and support surfaces.

Over time, cleaning solutions may cause damage to the integrity of the fabrics used for support surfaces. Cleaning agents that are strong enough to be efficacious cleaners and disinfectants may cause degradation of the same fabrics on which they are being used.

To minimize the negative impact of cleaning agents:

- Contact time must be monitored and kept to the required time identified on the manufacturer's instructions.
- All cleaning solutions must be diluted in accordance with manufacturer's instructions.
- All covers must be rinsed after every cleaning cycle. Rinsing of the support surface covers with clean water as the immediate step after the disinfection process is fundamental to extending the usable life of the covers.

NOTE: Only the outer cover of the mattress requires cleaning and maintenance. Disassembly of the support surface for maintenance of internal components is not recommended. DO NOT use harsh solvents or cleaners. Special care should be used to not puncture the mattress with needles or sharp instruments. This may result in loss of integrity of the mattress cover or internal components.

NOTE: For a list of recommended EPA registered disinfectants, stain removers, and *Clostridium difficile* (C. diff) prevention, please contact Agiliti.

The recommended wipes meet the CDC's recommendations for *Clostridium difficile* (C.diff) bacteria, after the manufacturer's recommended "wet contact time".

1. Perform hand hygiene using soap and warm water, or hand sanitizer, and then put on disposable gloves and eye protection.
2. Use wipes to wipe the top and front of head/footboards, hand controls and cords, siderails and mattress top cover, making sure to wipe between the mattress and side rails.
3. Change wipes often to ensure that surfaces remain wet with disinfectant for the manufacturer's required contact time. Used wipes are to be discarded in the trash.
4. Remove disposable gloves and discard in the trash; perform hand hygiene using soap and warm water, or hand sanitizer, and then remove eye protection.

To reduce the discoloration of fabrics and degradation of the sleep surface lining, surfaces must be thoroughly rinsed with clean, fresh water to remove chemical residues immediately after the manufacturer's recommended "wet contact time" has been reached. The use of bleach-based solutions must be avoided whenever possible.

Cleaning Instructions

Mattress Top Cover

Personal Protective Equipment should always be used as directed by the disinfectant's Material Safety Data Sheet.

1. Prepare the disinfectant according to the manufacturer's recommendations.
2. Prepare a separate bucket of warm, fresh water to be used for rinsing the equipment after cleaning/disinfecting procedures are completed as instructed.
3. All surfaces of the mattress are to be wiped using a coarse cloth dampened with the disinfectant, prepared as directed by the manufacturer's recommendations, to remove organic material and visible soil.
4. Allow the mattress shell to remain wet with disinfectant solution for the manufacturer's recommended contact time.
5. Stains on the mattress top cover may be treated using an approved stain remover, according to the manufacturer's recommendations.

Rinse all surfaces of the mattress with fresh water and clean cloth to remove chemical and organic residue.

Laundry Instructions

If additional cleaning is necessary, top covers may be removed and laundered using standard hospital disinfectant/detergent. DO NOT use temperatures in excess of 120°F (49°C).

1. Set washing machine to Regular Cycle.
2. Pre-soak with disinfectant/detergent in cold water for 10 minutes. DO NOT USE HARSH SOLVENTS OR CLEANERS.
3. Main wash cycle: 15 minutes (time dependent on soil level).
4. Rinse cycle: 5 minutes, minimum.
5. Spin/Drain cycle: 5 minutes, minimum.

After washing, the mattress top cover is to be air dried or dried in a dryer at very low or no heat to protect it from heat related damage.

Mattress Base

1. Prepare the disinfectant according to the manufacturer's recommendations.
2. Prepare a separate bucket of warm, fresh water to be used for rinsing the equipment after cleaning/disinfecting procedures are completed as instructed.
3. All surfaces of the mattress are to be wiped using a coarse cloth dampened with the disinfectant, prepared as directed by the manufacturer's recommendations, to remove organic material and visible soil.
4. Allow the mattress shell to remain wet with disinfectant solution for the manufacturer's recommended contact time.
5. Stains on the mattress base may be treated using an approved stain remover, according to the manufacturer's recommendations.
6. Rinse all surfaces of the mattress with fresh water and a clean cloth to remove chemical and organic residue.
7. After washing, the mattress base must be allowed to air dry.

Cleaning Instructions

Air Therapy Internal Mattress Components

1. Prepare the disinfectant according to the manufacturer's recommendations.
2. Prepare a separate bucket of warm, fresh water to be used for rinsing the equipment after cleaning/disinfecting procedures are completed as instructed.
3. Using a clean cloth dampened with the disinfectant solution, wipe all internal mattress surfaces, including the air cells, and allow to remain wet for the manufacturer's recommended contact time.
4. Rinse all surfaces of the air cells with fresh water and clean cloth to remove chemical and organic residue.
5. After cleaning, dry the internal air cells with a clean, dry cloth.
6. After all mattress components are dry, reinstall the top cover.

Store the mattress in a "clean" environment until the next use.

Cleaning Blood and Other Excretions

Blood and other excretions should be wiped up while wet, if possible. These substances are more difficult to remove once they have dried to surfaces. Dried blood and other excretions are to be removed using ample disinfectant solution in order to moisten the substance and make it easier to clean.

Control Unit Cleaning Instructions

NOTE: Hand clean only. DO NOT place in sterilization room or chamber.

1. Personal Protective Equipment should be used as directed by the Material Safety Datasheet for the disinfectant.
2. Prepare the disinfectant according to the manufacturer's recommendations.
3. Turn off the control unit and disconnect it from all electrical power to avoid electrical shock.
4. When cleaning the control unit avoid excessive moisture, especially in areas where there are electrical connections and components, to prevent damage.
5. All surfaces of the control unit and the power cord are to be wiped using a coarse cloth, dampened with the disinfectant solution prepared as directed by the manufacturer's recommendations, to remove organic material and visible soil.
6. Allow the control unit to remain wet with disinfectant solution for the manufacturer's recommended contact time.
7. Rinse all surfaces of the control unit with fresh water and use a clean cloth to remove chemical and organic residue.

After cleaning, all surfaces are to be dried with a clean, dry cloth.

Filters

NOTE: To keep equipment working efficiently and effectively for an extended time period, it is essential to make sure the equipment is cleaned regularly and well maintained.

NOTE: DO NOT attempt to clean HEPA filters, as they are to be removed and replaced only.

To clean open cell foam air filter ONLY:

1. Remove the air filter located on the back of the control unit.
2. Clean with prepared disinfectant solution and allow to air dry.
3. Reinstall the filter when dry.

Maintenance



CAUTION: The mattress requires regular maintenance to ensure performance and avoid premature wear, damage and injury.

Check the items on this chart at the indicated intervals. If any of the items are loose, worn, bent or distorted immediately have them checked and/or repaired by an authorized Agiliti technician. Frequent maintenance and servicing will improve performance and extend product life.

Description	Weekly	Monthly	Quarterly
Open Cell Foam Filter	X		
HEPA Filter		X	
Top Cover		X	
Mattress Base		X	
Mattress Connections			X
Control Unit Operation			X
Power Cord			X

The following is an equipment safety checklist that can be used with the maintenance chart to maintain and service this product:

- Inspect top cover for punctures, rips, tears or damage.
- Inspect mattress base for punctures, rips, tears or damage.
- Connect the control unit and verify proper operation (if installed).
- Ensure air filter is clean and properly installed into control unit (if installed).
- Ensure mattress is clean/disinfected and patient ready.

All power cords are fastened in a manner to keep them free from moving or pinching parts. At any time parts are replaced, all cords should be secured into proper position to prevent damage.

Maintenance

HEPA Filter

Information

- Each Unit is equipped with one open cell foam air filter and one high efficiency particulate air (HEPA) filter.
- HEPA filters aid in contamination control for facilities.
- HEPA filters do not filter out gases and odor molecules such as chemical vapors and cigarette smoke.
- HEPA filter must be used in conjunction with the manufacturer supplied foam filter.
- DO NOT attempt to install HEPA filter without the original equipment foam filter. Ensure factory open cell foam filter is completely dry before placing HEPA filter in unit.
- The HEPA filter is to be installed in applicable models and pumps in conjunction with the next factory filter cleaning procedure.
- DO NOT MODIFY HEPA filter for installation. Order filter from Agiliti to receive filter with correct dimensions.
- DO NOT attempt to clean HEPA filters, as they are to be removed and replaced only.

Installation

- Installation and/or handling of HEPA filter requires PPE. Service personnel should wear a mask, gloves, and protective clothing to avoid exposure to possible contaminants.
 - Tools are not required for installation of filter.
 - Ensure unit is off and/or removed from power source prior to servicing or replacement of filter or HEPA filter.
1. Locate and remove factory filter on the top and back of the case.
 2. Filter is easily removed and reinserted through the gap in the back of the case.
 3. Ensure HEPA filter is clean.
 4. Place HEPA filter on front of factory foam filter.
 5. Re-install filters in control unit case.



Open Cell Foam Air Filter

The foam air filter on the back of the control unit must be cleaned weekly with disinfectant solution (see cleaning section). Replacement of the foam filter is recommended every 6 months.

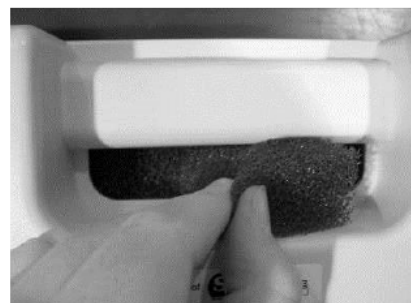

Troubleshooting



ELECTRICAL SHOCK HAZARD WARNING: To avoid electrical shock, DO NOT open the control unit. Refer servicing to qualified personnel only.



CAUTION: Only authorized personnel should engage in the troubleshooting process. Troubleshooting by unauthorized persons could result in personal injury or equipment damage.

NOTE: If troubleshooting process does not solve the problem, please contact an Agiliti representative for further assistance.

Problem	Troubleshooting
Mattress not inflating	<ul style="list-style-type: none"> – Check that the hoses are not punctured, kinked or disconnected. – Check for proper connections from the hoses to the control unit. Make sure they are secure. – Check air filters on back of control unit and clean if necessary. – Ensure CPR function is in the closed position.
Power loss	<ul style="list-style-type: none"> – Check the ON/OFF switch. – Check power cord for any damage. – Unplug the Control Unit and check fuses located near the main ON/OFF switch. Replace fuse/s as necessary. – Ensure unit is plugged into a working power outlet.
Reduced air flow	<ul style="list-style-type: none"> – Check for possible obstructed/contaminated foam filter. Replace as necessary. – Check for possible obstructed/contaminated HEPA filter. Replace as necessary.
Excessive control unit noise	<ul style="list-style-type: none"> – Check for possible obstructed/contaminated foam filter. Replace as necessary. – Check for possible obstructed/contaminated HEPA filter. Replace as necessary.
Odor	<ul style="list-style-type: none"> – Check for excessive contamination on HEPA filter. Replace as necessary.

Fuses

- To open: insert flat head screwdriver into the center slot and turn counterclockwise.

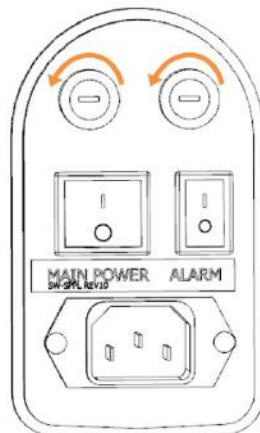

Frequently Ordered Parts

The following is a list of parts that are frequently ordered for self-replacement and repairs. To aid in ordering parts, please use the provided product numbers given below for each part. The replacement of some parts not listed here may require sending in the unit to the manufacturer for repairs.



Connector (short)
Connects from mattress to control unit side panel. Allows air movement to inflate mattress.
Part Number 61611600



Connector (long)
Connects from mattress to control unit side panel. Allows air movement to inflate mattress.
Part Number 61611611



Power Cords
Grounded hospital grade power cord for providing power to the control unit. (Note: Supplied only with 110V control units).
Part Number 27000445



Filters Removes dust and other particles from the air as they are pulled into the control unit.
Stock filter Part Number 27400048
HEPA Filter Part Number 27400059



Hooks
Hinged hooks that allow the unit to be hung on bed frame.
Part Number 27400045



Brackets
Attach the hooks to the bottom case of the unit.
Part Number 27502020

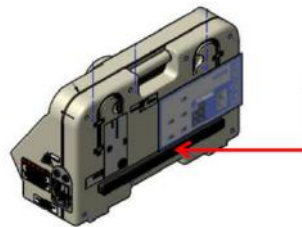

Bumper Pad
Part Number 27500042

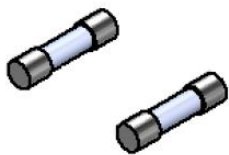

Fuse/s: 6.3A 250V.
Part Number 27503598

Top Cover
Replacement waterproof, vapor permeable cover.
Part Numbers Vary (contact 1-800-814-9389 for additional information)

Storage and Disposal



CAUTION: Keep out of direct sunlight.



CAUTION: DO NOT expose to temperatures below 0°F (-18°C) or above 95°F (35°C).



CAUTION: DO NOT expose to moisture or areas of humidity greater than 95%.

Keep the mattress in a clean dry area, away from heat or flames. Store the unit and mattress in a temperature range between 0°F (-18°C) and 95°F (35°C). Always store the surface flat on a clean, level surface. Avoid storage of other equipment on top of the support surface. DO NOT expose the control unit to humidity greater than 95%.

End-of life Agiliti products must be disposed of properly according to local laws and regulations. Please contact Agiliti or your local authorities for disposal and recycling options.

If storing product for more than 30 days, it is recommended:

- Remove HEPA filter.
- Place HEPA filter in an air-tight plastic bag or plastic wrap ensuring filter is sealed to prevent exposure to outside contaminants.
- When you wish to operate product, reinstall HEPA filter.

Limited Product Warranty

Pulsate™

PLEASE READ THESE WARRANTY TERMS AND CONDITIONS CAREFULLY BEFORE USING YOUR AGILITI PRODUCT. BY USING THE PRODUCT, YOU ARE CONSENTING TO BE BOUND BY THE FOLLOWING WARRANTY TERMS AND CONDITIONS.

Limited Warranty

Raye's, Inc dba Sizewise Manufacturing ("Sizewise Manufacturing") warrants the above referenced product to be free from material defects in materials and workmanship for the warranty periods set forth below when the product is used and serviced properly in accordance with the specifications set forth in the Agiliti user manual in effect at the time of sale of the product, including without limitation the safety instructions and if applicable the safe working load and weight limitations set forth therein. If there is no period of time specified below, the warranty period shall be ninety (90) days. Unless agreed to otherwise in writing by Sizewise Manufacturing, the warranty periods commence on the invoice date of the original purchase. This warranty applies only against defects discovered within the warranty period and extends only to you, the Buyer. As used in this warranty Buyer means the original purchaser or original end user of the product designated at the time of purchase. Any reference to "you" is as the Buyer. Parts repaired or replaced under the terms of this warranty will be warranted for the remainder of the original warranty period only. Buyer is solely responsible for determining whether the products and services offered by Sizewise Manufacturing are appropriate for its intended use including use by Buyer's employees, invitees, contractors, representatives, third party beneficiaries, or any other person Buyer intends to use the product. Buyer acknowledges it has made the selection of the products based upon its own judgment and that the product is of a size, design, capacity, condition, quality, and durability selected by Buyer. Buyer expressly disclaims any reliance upon any statements or representations made by Sizewise Manufacturing or any other party on its behalf except as otherwise specifically provided for in this Limited Product Warranty. Buyer acknowledges and agrees that the remedy in this warranty for the repair and replacement of defective product or part(s) shall constitute the sole remedy in the event of a defective product or part(s).

THE WARRANTY GIVES YOU SPECIFIC LEGAL RIGHTS, AND YOU MAY ALSO HAVE OTHER RIGHTS THAT VARY FROM STATE TO STATE. Sizewise Manufacturing's obligations under this warranty are limited as set forth below.

Warranty Period and Coverage:

Product	Control Unit	Mattress	Top Cover	Electronics
Pulsate™	1 year	2 year limited	90 days	1 year

Limited Product Warranty

Conditions and Restrictions

This warranty is valid only in accordance with the conditions set forth below:

The warranty applies to this Agiliti product only while:

- it remains in the possession of the Buyer and proof of purchase is demonstrated,
- it has not been subjected to accident, misuse, abuse, improper service, or modification,
- Claims are made within the warranty period.
- This warranty does not apply to any other products or devices sold separately regardless of whether used with this product. Such other products or devices, to the extent sold with a warranty, will be subject to the separate limited product warranty set forth in the user manual for such product or device.
- Sizewise Manufacturing's sole liability shall be discharged by replacing or repairing, at Sizewise Manufacturing's option, the product or its part or parts which are determined by Sizewise Manufacturing to be defective under normal and proper use during the warranty period.
- Buyer shall notify Sizewise Manufacturing or the authorized Sizewise Manufacturing dealer immediately but in no event more than seven (7) days after the date of discovery of any alleged defect by contacting Sizewise Manufacturing Parts and Service at 800-814-9389 Monday through Friday 8am-5pm local time.
- If the product or part should be returned to Sizewise Manufacturing, a return authorization number (RA#) must be obtained by Buyer from Sizewise Manufacturing. The RA# will be valid for 21 days from the date it is issued.
- Buyer is responsible for any shipping, freight, handling, pickup, or delivery charges or fees including without limitation any expediting fees involved with the delivery of the defective product or parts to Sizewise Manufacturing's factory for repair or replacement.
- If on-site technical service is required, as determined by Sizewise Manufacturing, a service representative will be dispatched during Sizewise Manufacturing's standard service hours Monday through Friday 8am-5pm local time, provided the product is located within Sizewise Manufacturing's service territory.
- If Sizewise Manufacturing determines the problem with the product or part(s) is a result of defective material or workmanship, the product or part will be replaced or repaired at the discretion of Sizewise Manufacturing, and at no charge to the Buyer; however, this is subject to the limitations and exclusions of this Limited Product Warranty.
- At the election of Sizewise Manufacturing, replacement parts may be new or refurbished; Sizewise Manufacturing reserves the right to substitute materials if original materials are no longer available.
- If Sizewise Manufacturing determines the product or part that Buyer has requested warranty services on are not covered by the warranty for any reason including, without limitation, because it is outside of the warranty period, excluded from the warranty, or the warranty is void, Buyer shall pay for the repair or replacement services, including parts and labor performed by Sizewise Manufacturing at Sizewise Manufacturing's prevailing time and material rates plus freight and delivery.
- If Buyer declines the repair or replacement service upon notice from Sizewise Manufacturing that it is not covered under warranty, Buyer shall reimburse Sizewise Manufacturing for all costs from investigating and responding to Buyer's request.
- Any costs to Buyer as referred to herein shall be at Sizewise Manufacturing's prevailing time and material rates plus any freight and delivery charges incurred by Sizewise Manufacturing.
- Any assistance provided by Sizewise Manufacturing outside the terms of this warranty does not waive the limits of this warranty.
- Sizewise Manufacturing does not pay labor outside the United States.
- Any description of Sizewise Manufacturing's products is for identification purposes only and is not an express warranty.
- Loaned products, demo or sample products, and/or consumable products including without limitation batteries and sheets are furnished to Buyer on an "AS IS WITH ALL FAULTS" basis.

Limited Product Warranty

EXCLUSIONS AND LIMITATIONS

This Limited Product Warranty shall not apply to the below listed events, occurrences, actions and/or items. Sizewise Manufacturing shall have no obligation to make repairs, replace, or correct products including any part or parts of the product as the result of Sizewise Manufacturing's determination of any of the following:

- Software (PROM) or firmware version upgrades or updates or any other changes and/or any outages, interruptions, delays, attacks, malware, or any other technology or viruses on such software or firmware or Buyer's network, if applicable to this product.
- Normal wear and tear of the product including, without limitation, normal discoloring, body impressions on mattresses or loss in some resiliency, if applicable to this product, and/or any cosmetic items, consumable items including, without limitation, mattresses, casters, sheets, handsets, and batteries as these items are not covered by this warranty.
- Damage due to improper transport, storage, installation, maintenance, use, repair, or failure to follow Sizewise Manufacturing's instructions or procedures as detailed in the user manual.
- Damage or malfunctions resulting from work performed by service providers not authorized by Sizewise Manufacturing.
- Repairs performed on a Agiliti product or parts missing a serial number or with a serial tag that has been altered, tampered with, or defaced in any manner.
- Service calls to correct installation of the product unless installed under contract by Sizewise Manufacturing or its partners and with regard to installation, the terms of the service contract only shall apply to service installation corrections, not this warranty.
- Shipping, freight, handling, pickup, and delivery charges or fees involved with delivery of the products and or part(s) to Sizewise Manufacturing's factory for repair or replacement and returning the replacement or repaired products and/or parts to Buyer.
- Any labor costs incurred beyond the applicable labor warranty period.
- Damage or product failure from causes external to the product or part(s) including, without limitation, power or electric failure or surges, electrical wiring not in compliance with electrical codes, or Sizewise Manufacturing user manual specifications.
- Damage caused by failure to provide reasonable and necessary maintenance as outlined in the user manual.
- Damage caused by the use, misuse, negligence, loss, or abuse of the product or any parts by Buyer, including without limitation any third-party beneficiaries, end user, caregivers, patients, or any others that Buyer intends to use the product, including, without limitation, (except Sizewise Manufacturing or an authorized Sizewise Manufacturing service provider):
 - o exceeding any specified weight limitations in any product documentation such as the user manual and, including without limitation as applicable to the product, the Safe Working Load, Maximum Patient Weight, and/or Maximum Load as those terms are defined in the product documentation, user manual and by applicable regulations,
 - o to the extent the product specifies a minimum load/weight criteria including without limitation a Minimum Patient Weight in order for it to function properly, then any use not in compliance therewith.
 - o cleaning upholstery or fabrics with harsh chemicals, or bleach, outside the recommended cleaning guidelines,
 - o altering, tampering with, or modifying in any manner without the express written consent of Sizewise Manufacturing any part(s) or structural components or appurtenances of the products,
 - o use of the product or part(s) in any manner for which it is not designed or in any manner inconsistent with the information set forth in the Sizewise Manufacturing user manual, including, without limitation, use with other devices, accessories, cables or ancillary products including without limitation inappropriate replacement parts and/or repairs, for which it was not intended.

Limited Product Warranty

- Exposure of the product or part(s) to accident, acts of God, or natural causes (such as natural disasters, fire, flood, wind, water or power failures, or any acts or threats of terrorism, both domestic and foreign) whether foreseen or unforeseen.
- Operation of the product beyond its normal useful life.
- Buyer's failure to show proof of purchase.
- Products or items not manufactured by Sizewise Manufacturing. Rather, for products or items obtained by Sizewise Manufacturing from an original manufacturer or third-party supplier, Sizewise Manufacturing may assign to the Buyer any warranty rights in such products or items that Sizewise Manufacturing may have from the original manufacturer or third-party supplier to the extent such assignment is allowed by the original manufacturer or third-party supplier

Limited Product Warranty

Disclaimer and Release

The warranties provided herein are the exclusive warranties given by Sizewise Manufacturing and supersede any prior, contrary, or additional representations or warranties, whether oral or written. TO THE EXTENT NOT PROHIBITED BY LAW, THIS WARRANTY IS EXCLUSIVE AND IN LIEU OF ALL OTHER WARRANTIES, ORAL, WRITTEN, STATUTORY, EXPRESS OR IMPLIED. EXCEPT FOR THE EXPRESS WARRANTIES IN THIS LIMITED PRODUCT WARRANTY AND TO THE EXTENT NOT PROHIBITED BY LAW, SIZEWISE MANUFACTURING DISCLAIMS ANY AND ALL OTHER WARRANTIES WHETHER EXPRESS OR IMPLIED WARRANTIES, STATUTORY OR OTHERWISE, INCLUDING, WITHOUT LIMITATION, ANY WARRANTIES OF MERCHANTABILITY, FITNESS FOR A PARTICULAR PURPOSE OR NON-INFRINGEMENT, AND ANY WARRANTIES ARISING FROM COURSE OF DEALING, USAGE OF TRADE, OPERATION OF LAW, OR OTHERWISE WITH RESPECT TO ANY PRODUCT, SERVICES, PARTS INCLUDING REPAIRED OR REPLACED PRODUCTS AND PARTS ARE HEREBY DISCLAIMED AND EXCLUDED . SIZEWISE MANUFACTURING ALSO HEREBY DISCLAIMS AND EXCLUDES ALL OTHER OBLIGATIONS OR LIABILITIES, EXPRESS OR IMPLIED, ARISING BY LAW OR OTHERWISE, WITH RESPECT TO ANY NONCONFORMANCE OR DEFECT IN ANY PRODUCT OR PART(S), INCLUDING BUT NOT LIMITED TO: (A) ANY OBLIGATION, LIABILITY, RIGHT, CLAIM, OR REMEDY IN TORT, WHETHER OR NOT ARISING FROM THE NEGLIGENCE OF SIZEWISE MANUFACTURING OR ITS SUPPLIERS (WHETHER ACTIVE, PASSIVE, OR IMPUTED); AND (B) ANY OBLIGATION, LIABILITY, RIGHT, CLAIM, OR REMEDY FOR LOSS OF OR DAMAGE TO ANY PRODUCT OR PART(S) . This disclaimer and release shall apply even if the express warranty set forth above fails of its essential purpose. SOME STATES DO NOT ALLOW DISCLAIMERS OF IMPLIED WARRANTIES, SO THIS DISCLAIMEEER MAY NOT APPLY TO YOU. TO THE EXTENT SUCH WARRANTIES CANNOT BE DISCLAIMED UNDER THE LAWS OF YOUR JURISDICTION, SIZEWISE MANUFACTURING LIMITS THE DURATION AND REMEDIES OF SUCH WARRANTIES TO THE DURATION OF THIS EXPRESS LIMITED WARRANTY.

Exclusive Remedies

For any product described above that Sizewise Manufacturing determines to have failed to conform to this limited warranty, Sizewise Manufacturing will provide, at its option, one of the following:

- (1) Repair.
- (2) Replacement; or
- (3) Refund of the purchase price.

Sizewise Manufacturing Limited Product Warranty service may be obtained by contacting Sizewise Manufacturing or the authorized dealer from whom Buyer purchased the item. Sizewise Manufacturing compensates only Sizewise Manufacturing-authorized service providers for warranty trips within their normal service area to repair commercial products at the customer's location.

THESE SHALL BE THE SOLE AND EXCLUSIVE REMEDIES OF THE BUYER FOR ANY BREACH OF WARRANTY.

Limited Product Warranty

EXCLUSION OF CONSEQUENTIAL AND INCIDENTAL DAMAGES

SIZewise MANUFACTURING AND/OR ITS SUPPLIERS SHALL HAVE NO OBLIGATION OR LIABILITY, WHETHER ARISING IN CONTRACT (INCLUDING WARRANTY), TORT, OR ANY OTHER LEGAL THEORY (INCLUDING ACTIVE, PASSIVE, OR IMPUTED NEGLIGENCE AND STRICT LIABILITY), OR OTHERWISE, FOR DAMAGE TO THE PRODUCT INCLUDING PART(S), PROPERTY DAMAGE, DEATH, PERSONAL INJURY, LOSS OF USE, GOODWILL, REVENUE OR PROFIT, COST OF CAPITAL, COST OF SUBSTITUTE PRODUCT, ADDITIONAL COSTS INCURRED BY BUYER (BY WAY OF CORRECTION OR OTHERWISE), OR ANY OTHER INCIDENTAL, SPECIAL, INDIRECT, COMPENSATORY, OR CONSEQUENTIAL DAMAGES, INCLUDING, WITHOUT LIMITATION, WHETHER RESULTING FROM NONDELIVERY, USE, MISUSE, OR INABILITY TO USE THE PRODUCT, SERVICES OR PART(S) . This exclusion applies even if the above warranty fails of its essential purposes and regardless of whether such damages are sought for breach of warranty, breach of contract, negligence, or strict liability in tort or under any other legal theory. SIZewise MANUFACTURING LIABILITY SHALL under no circumstance exceed THE AMOUNT PAID BY BUYER FOR THE RELEVANT defective PRODUCT. SOME STATES DO NOT ALLOW THE EXCLUSION OR LIMITATION OF INCIDENTAL OR CONSEQUENTIAL DAMAGES, SO THE ABOVE LIMITATION AND EXCLUSION ON SUCH MAY NOT APPLY to you.

Limited Product Warranty

EXTENDED WARRANTY

If the product covered under the Limited Product Warranty set forth herein had from Sizewise Manufacturing an extended warranty option made available only at the time of the Buyer's original purchase from Sizewise Manufacturing, Buyers who then also purchased such extended warranty, and have proof of such purchase, may extend the warranty period stated above in the Limited Product Warranty on parts, electronics, frame, and labor relating to parts, electronics, and frame repairs, as applicable, for an additional one (1) or two (2) years, whichever extension is purchased by Buyer ("extended warranty period"). Other than the extension on the warranty period, all other terms of the limited product warranty including without limitation the conditions and restrictions, exclusions and limitations, disclaimer and release, and exclusion of consequential and incidental damages of the original limited product warranty apply during the extended warranty period. For the purpose of clarity, an extended warranty is not available where the original warranty period is less than one (1) year, and an extended warranty may only be purchased by Buyer at the time of the original purchase of the product from Sizewise Manufacturing.

To make a warranty claim, contact:

RAYE'S, INC. DBA SIZEWISE MANUFACTURING

PO BOX 320

ELLIS, KS 67637

800-814-9389 Monday through Friday 8am-5pm local time

Complete this portion and keep for your records.

Purchased From: _____

Product/model: _____

Serial number: _____

All specifications, equipment, and prices are subject to change without notice. Photos and drawings are representative of the products and may vary slightly from actual production models. All content Copyright Agiliti Health, Inc.

Raye's, Inc., d/b/a Sizewise Manufacturing (f/k/a Wheelchairs of Kansas and Sunflower Medical), is a wholly owned subsidiary of Sizewise Rentals, LLC. Sizewise Rentals, LLC is a wholly owned subsidiary of Agiliti Health, Inc.

For service or support, call 800-814-9389.

